

*Make Things
Possible*

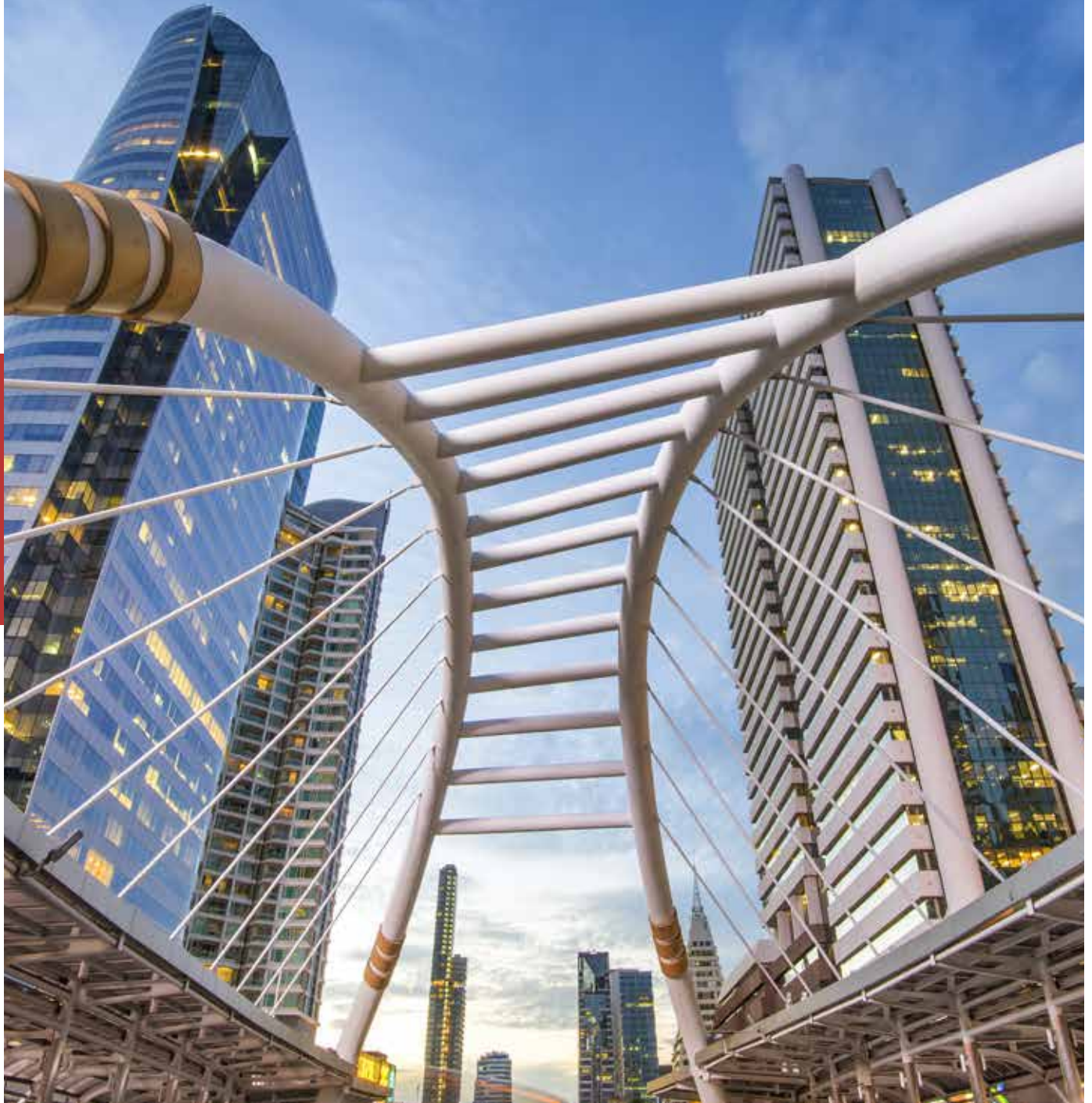

Pacific Pipe Public Co., Ltd.

บริษัท แปซิฟิกไพพ์ จำกัด (มหาชน)



บริษัท แปซิฟิกไพพ์ จำกัด (มหาชน)
派茂盛鐵管廠(大眾公司)
Pacific Pipe Public Company Limited



VISION

Your Partner For
Total Solutions.

VALUE



Creativity



Harmony

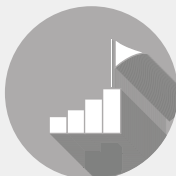

Achievement
Orientation



Networking



Growth



Entrepreneurship

Pacific Pipe Public Company Limited

Pacific Pipe Public Company Limited was established in 1972 in the name of “Tang Mong Seng Factory”, originally producing toy cars. By the year 1991, the company has expanded in to producing and distributing various types of steel pipes under the name of Pacific Pipe Company Limited.

Pacific Pipe Company Limited has been growing and expanding economically since the establishment. As a result, the company is registered as Pacific Pipe Public Company Limited in 2004. Therefore, we are Thailand’s the leading company in producing and distributing steel pipes, which includes steel pipes used in construction, and pipeline systems. Our products include round steel pipes, square steel pipes, rectangular steel pipes, lip channel steel pipes, black steel pipes, galvanized steel pipes, and primer-coated steel pipes as to your requirement.

In the present, our company has the capability to manufacture black steel pipes and lip channel steel pipes in the total of 450,000 tons, and 50,000 tons of galvanized steel pipes per year.

With our experience and expertise in producing high quality steel pipes by using advance machineries and modern technology in coherence with quality control department under the supervision of highly qualified engineers, our products are qualified and meet the international standards. Moreover, our products are certified by many international standards and widely recognized in both domestic and international markets.



Content

- 02 Product
- 03 Applications-Specifications-Raw Material Grades
- 04 Production Process
- 06 Quality Inspection
- 07 Quality Certification
- 08 Production Capacity



14



26



52

Carbon Steel Pipes for ORDINARY PURPOSES & PIPING SYSTEM

- 14 ASTM A53
- 16 ASTM A795
- 17 AS 1074
- 18 BS EN 10255
- 19 JIS G3452
- 20 JIS G3454
- 21 TIS 276 & TIS 277
- 22 TIS 427
- 23 TIS 770

- 46 Summary Standard Specifications
- 52 Reference Projects Pacific Pipe Products

Carbon Steel Pipes for GENERAL STRUCTURE PURPOSES

- 26 ASTM A500
- 29 AS 1163
- 32 BS 1139
- 32 BS EN 10219
- 36 JIS G3444
- 37 JIS G3466
- 39 TIS 107
- 42 TIS 1228
- 44 JIS Modified



Product

Steel Pipes That Pacific Pipe Public Company Limited Produces Can Be Categorized In To 3 Main Types :

1

International Industrial Standard Steel Pipes

Products that are used for the structure purposes in construction and for pipeline systems. The steel pipes consist of chemical components, dimensions, thickness, weight etc. comply with the international standard specifications :

Specification		for Piping System	for Structure Purposes
ASTM	American Society of Testing and Materials	ASTM A53, ASTM A795	ASTM A500
AS	Australian Standards	AS 1074	AS 1163
BS	British Standards	BS 1387	BS 1139
DIN	Deutsches Institut für Normung e.V.	DIN 1626	DIN 17120
EN	European Standards	BS EN 10255	BS EN 10219
JIS	Japanese Industrial Standards	JIS G3452, JIS G3454	JIS G3444, JIS G3466
TIS	Thai Industrial Standards	TIS 276, TIS 277, TIS 427, TIS 770	TIS 107, TIS 1228

2

Company Standard Steel Pipes

Products that are used in minor construction works such as awning frames, doors, fences, railing, stables and stockyards, tents, flagpoles, etc. The steel pipes consist of chemical components, dimensions, thickness, weight etc. comply with company standard specifications :

- Round Pipes
- Square Pipes
- Rectangular Pipes

Types Of Pipe Coating :

- Black Coating
- Primer Coating
- Galvanized Coating

3

Customized And Made To Order Steel Pipes

Products that are used for industrial purposes so as to be assembled into other forms of products. Our company is able to manufacture the steel pipes that have dimensions, weight, tolerance etc. according to customers requirement.

Applications Specifications Raw Material Grades

Carbon Steel Pipes for Ordinary Uses and Piping System

Application	Standard Specification	Grade	○ CHS		
			Black Pipe	HDG Pipe	Primer Coated Pipe
Sanitary Pipeline System, Fire Extinguishing System, Chilled Water-cooling Pipeline System for Air Conditioners, Agricultural Irrigation System, Water Treatment System, Municipal Water Supply System, etc.	ASTM A53	Grade A, B	✓	✓	✓
	ASTM A795	Grade A, B	✓	✓	✓
	AS 1074	-	✓	✓	✓
	BS 1387	-	✓	✓	✓
	BS EN 10255 (Transition from BS 1387)	-	✓	✓	✓
	JIS G3452	SGP	✓	✓	✓
	JIS G3454	STPG 370, STPG 410	✓	-	✓
	TIS 276	-	✓	-	✓
	TIS 277	-	-	✓	-
	TIS 427	-	✓	✓	✓
Conduit Pipe Work	TIS 770	-	-	✓	-

Carbon Steel Pipes for General Structural Purposes

Application	Standard Specification	Grade	○ CHS			□ SHS / □ RHS	
			Black Pipe	HDG Pipe	Primer Coated Pipe	Black Pipe	Primer Coated Pipe
Civil Engineering, Architecture, Piling and Scaffolding, Trusses, Post, Industrial Work and other.	ASTM A500	Grade A, B, C, D	✓	-	✓	✓	✓
	AS 1163	C 250, C 350, C 450	✓	-	✓	✓	✓
	BS 1139	-	-	✓	✓	-	-
	BS EN 10219	S235JRH, S275J0H, S275J2H, S355J0H, S355J2H	✓	-	✓	✓	✓
	JIS G3444	STK290, STK400, STK490, STK500	✓	-	✓	-	-
	JIS G3466	STKR400, STKR490	-	-	-	✓	✓
	TIS 107	HS 41, HS 50, HS 51	✓	-	✓	✓	✓
Roof Structure of Housing and Factories	TIS 1228	SSC 400				Lip Channel Steel	



1. RM Inspection

Inspecting the widths, thicknesses, mechanical properties, and chemical components of raw materials.

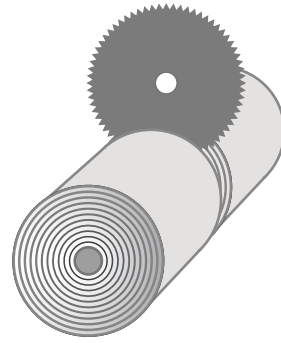

2. Slitting

Cutting the metal roll into specific sizes that are used to produce pipes.

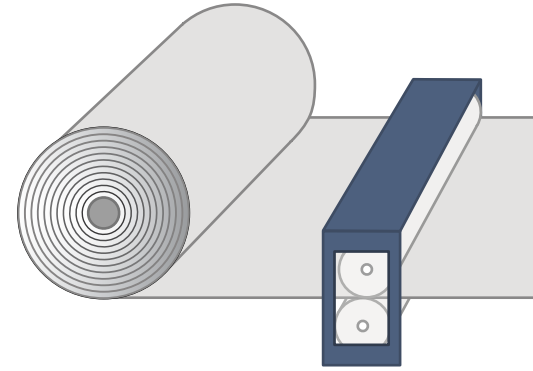

3. Uncoiling

Uncoiling the metal roll after cutting the metal roll in to preferred sizes.

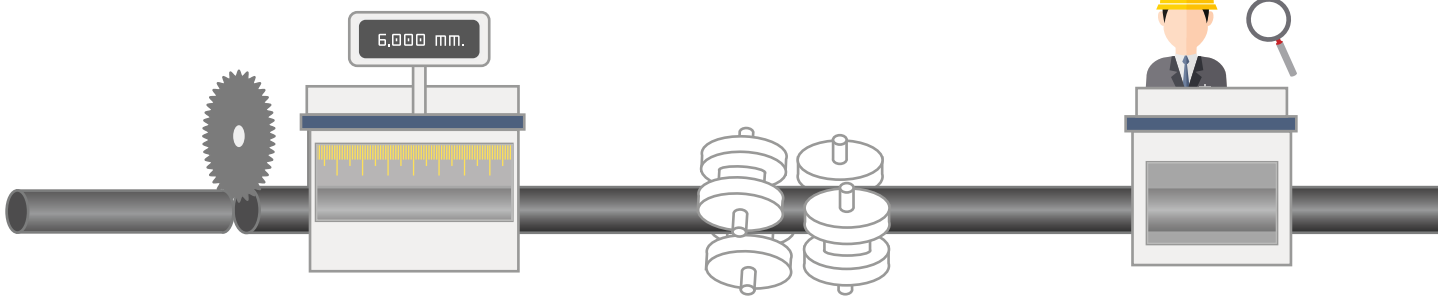

12. Cutting

Cutting the pipe into preferred lengths.

11. Sizing & Turk Head

Adjusting the sizes and forming the pipes into different shapes.

10. Eddy Current Test

Detecting and Characterizing surface and subsurface flaws of the seam area.

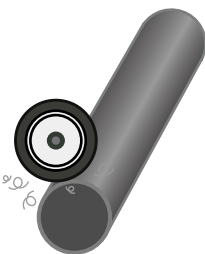

13. End Facing

Refining the end of the pipe's surface and shaping into 30, 45, 60, or 90 degrees angle.

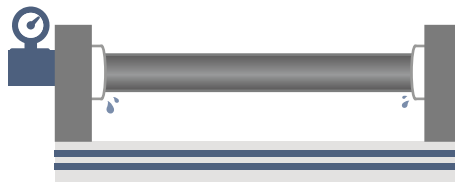

14. Hydrostatic Test

Detecting for leakage at the pipe seam area by using high pressure water (If identified in the standard specification)

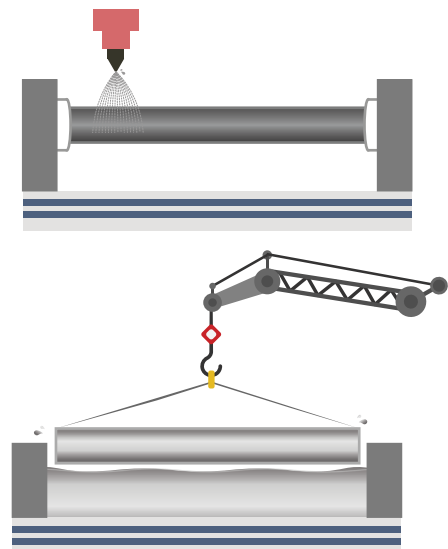

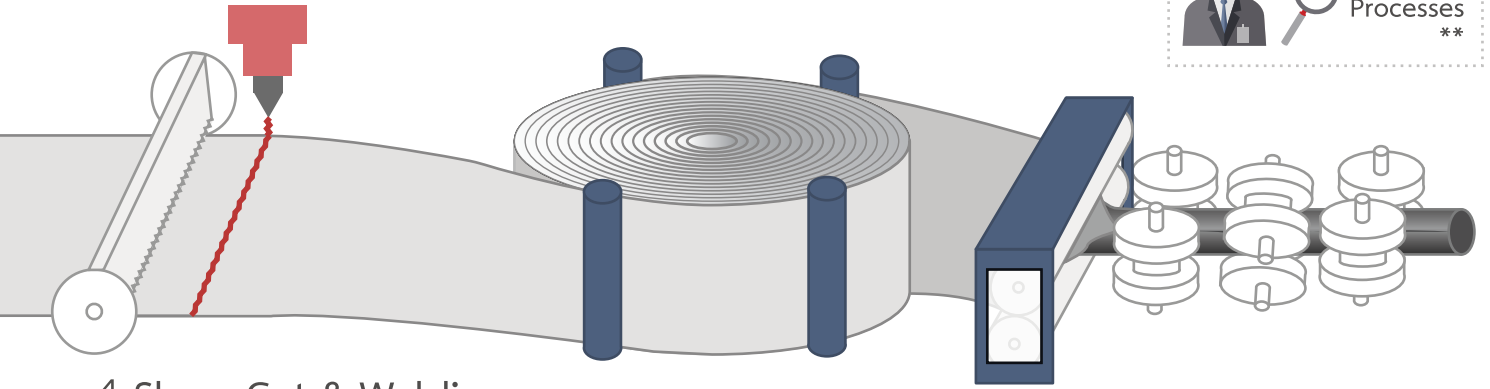

4. Shear Cut & Welding

Cutting the pre-cut metal roll into a straight line, and welding the edge of the metal roll to create continuity in the production process.

5. Accumulating

Collecting the cut metal roll into coil to create continuity of the rolling process.

6. Forming

Forming the metal roll into a cylinder shape before welding.

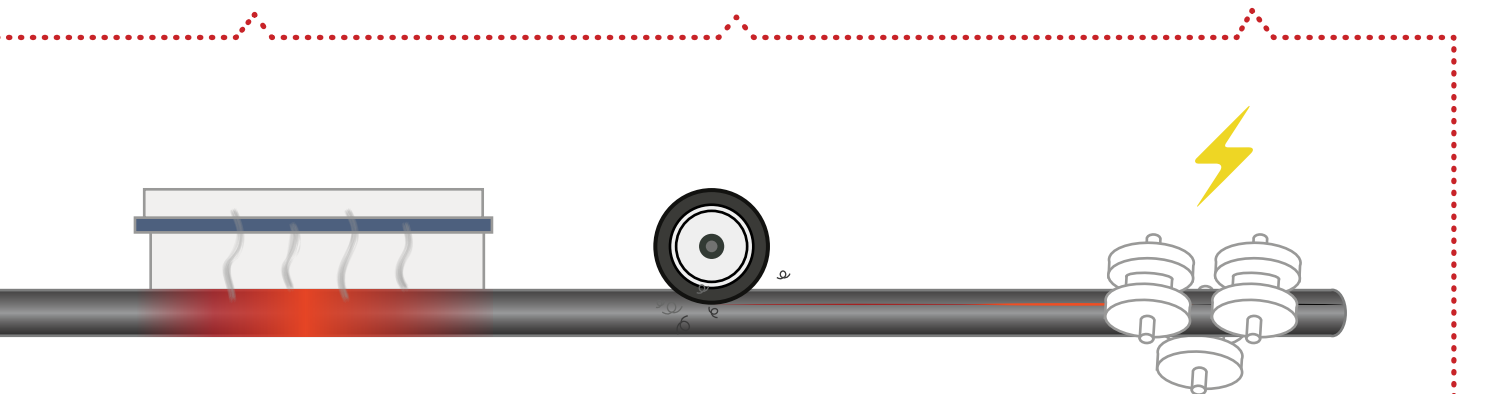

9. Annealing

Heating and cooling down the welded areas (If identified in the standard specification)

8. O.D Scarfing & I.D. Scarfing

Scarfing the inner and outer parts of the welded areas (If identified in the standard specification)

7. High Frequency Welding

Using the high frequency electromagnetic field to apply heat on both sides of the pipe and the rollers in order to weld the connecting joints firmly together.

15.1 Coating (Varnish, Primer)

Coating the surface of the pipe to prevent rust.



15.2 Hot Dip Galvanizing

Coating the surface of the pipe with a layer of zinc.

16. Threading

Threading the tips of the pipes.



17. Packing

Packing the pipes accordingly to the standards before distributing.

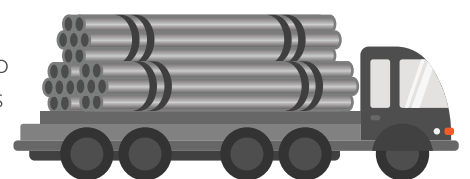

Production Process

Quality Inspection

Pacific Pipe Public Company Limited emphasizes on providing continually high quality products and services. Our company, therefore, has sustainable development policies and remodeling our production

processes with a certified quality inspection system performed by our professionals in order to manufacture products with high quality and standards. The quality inspection standards are as follows :

No.	Checking / Testing	Details	Piping System	Structure Pipe	
			○	○	□ □
1	Raw Material Inspection	Chemical Composition Test	√	√	√
		Tension Test	√	√	√
2	General Pipe Inspection	Straightness Inspection	√	√	√
		Appearance Inspection	√	√	√
3	Pipe Size Inspection	Outside Diameter Inspection	√	√	√
		Length Inspection	√	√	√
		Wall Thickness Inspection	√	√	√
		Weight Inspection	√	√	√
4	Pipe Weld Inspection	Eddy Current Test	√	-	-
5	Pipe Pressure Inspection	Hydrostatic Test	√	-	-
6	Mechanical Properties Inspection	Tension Test	√	√	√
		Bending Test	√	√	-
		Flattening Test	√	√	-
		Expansion Test	√	-	-
		Vibration Resistance Test	√	-	-
		Hydrostatic Test with Coupling	√	-	-
7	Stainless Coating Thickness Inspection	Zinc Thickness Test	√	-	-
		Primer Coat Thickness Test	√	√	√
8	Color Coating Thickness Inspection	Marking Durability	√	√	√
10	Pipe Tip Inspection	Plain Ends	√	-	-
		Groove Ends	√	-	-
		Threaded Ends	√	√	-



Quality Certification

Pacific Pipe Public Company Limited focuses on providing the highest quality products. In order to do so, our production process and quality control are performed accordingly to the standards. Each process of the manufacture and inspection is carefully checked and observed by our highly experienced and well

accomplished engineers. From this, our company has been certified for producing steel pipes used in construction and pipeline systems by the Industrial Standards Institute and numbers of well-known institutes worldwide, including FM, UL, JQA, and PSB.

Moreover, the company's calibration and testing laboratory and quality management have been certified, and have received the Environmental Governance Award.



Thai Industrial Standards (TIS)
 Thai Industrial Standards Institute (TISI)

TIS 310	Steel Pipes for making bicycles
TIS 107	Hollowed Steel Structures
TIS 276	Steel Pipes
TIS 277	Galvanized Steel Pipes
TIS 427	Electromagnetic Welded Steel Pipelines
TIS 770	Galvanized Steel Pipes for Power Conduit



Thai Industrial Standards (TIS)
 Thai Industrial Standards Institute (TISI)

TIS 1228	Structured Lip Channel Steel (Lip Channel Steel)
----------	--



Japan Quality Assurance Organization (JQA)
 Japan Quality Assurance Organization (JQA)

JIS G3444	Round Steel Pipes for Structure Works
JIS G3466	Rectangular Steel Pipes and Square Steel Pipes for Structure Works
JIS G3452	Steel Pipeline



TUD : TUV SUD PBS Singapore
 TUV SUD PBS Singapore

BS EN 10255 (from BS 1387)	Red Color Coated Steel Pipes and Galvanized Steel Pipes
-------------------------------	---



FM Standards approval of Automatic Fire Sprinkler Pipe
 FM Global, the United States of America

ASTM A53	Steel Pipes for
ASTM A795	Fire Extinguishing System
ASTM A135	



Underwriter Laboratories Standards approval of Metallic Sprinkler Pipe
 Underwriters Laboratories Inc., the United States of America

ASTM A53	Steel Pipes for Fire Extinguishing System
----------	---

Industrial Standards and certifications received by the company :



ISO Standard 9001 : 2015
 TUV NORD CERT Germany



ISO Standard 14001 : 2004
 TUV NORD CERT Germany



Occupational Health and Safety Management System (OHSMS) BS OHSAS 18001 : 2007 / TIS 18001 : 2011
 TUV NORD CERT Germany / TUV NORD Thailand



Calibration and Laboratory Standards ISO 17025 : 2005
 Thai Industrial Standards Institute (TISI)
 Industrial Standard Institute



Organization Carbon Footprint Standard
 Thailand Greenhouse Gas Management Organization
 Approval of Greenhouse Gas Assessment of the Organization



Low Emission Support Scheme Thailand
 Thailand Greenhouse Gas Management Organization
 Approval of Greenhouse Gas Reduction







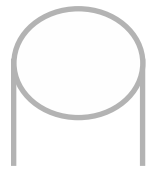



Green Industry Project Level 3 : Green System
 Department of Industrial Work

Production Capacity

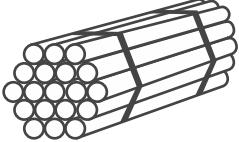
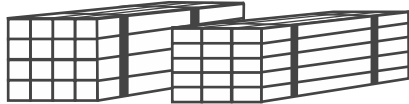

Type	Round Pipe	Square Pipe	Rectangular Pipe	Lip Channel
Size Range	Min : 1/2" (DN 15 mm) Max : 16" (DN 400 mm)	Min : 12 x 12 mm Max : 300 x 300 mm	Min : 38 x 19 mm Max : 400 x 200 mm	Min : 60 x 30 x 10 mm Max : 250 x 75 x 25 mm

Dimension / Property	Production Capacity			
Length	Standard Length 6 metres or As Required			
Thickness	1.2 mm - 12.7 mm			
Surface Finish Type	 Black Pipe	 Primer Coating	 Galvanized Coating	 Varnish Coating
Ends of Pipe	 Plain Ends (PE)	 Threaded Ends (TE)	 Beveled Ends (BE)	 Groove Ends (GE)
Standard Packing	 Round Pipe - Bundle in Hexagonal Shape		 Square Pipe / Rectangular Pipe - Bundle in Hollow Shape	



Our Steel Services

With extensive years of experience in the steel industry, we understand the project delay can often be occurred. To help clients minimize this problem and promoting superior structural works quality and value, we deliver broader steel services as follow.



Our Steel Services	
1	Cut to Length
2	Cut to Profile
3	Bending
4	Drilling
5	Primer Coating



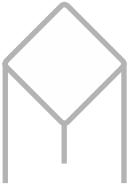

Production Capacity

Square Pipe

Size & OD	Nominal Dimension	
	inch	mm
	1/2" x 1/2"	12 x 12
	5/8" x 5/8"	16 x 16
	3/4" x 3/4"	19 x 19
	-	20 x 20
	1" x 1"	25 x 25
	1 1/8" x 1 1/8"	30 x 30
	1 1/4" x 1 1/4"	32 x 32
	1 3/8" x 1 3/8"	35 x 35
	1 1/2" x 1 1/2"	38 x 38
	1 5/8" x 1 5/8"	40 x 40
	-	45 x 45
	2" x 2"	50 x 50
	2 3/8" x 2 3/8"	60 x 60
	2 1/2" x 2 1/2"	65 x 65
	-	70 x 70
	3" x 3"	75 x 75
	3 1/8" x 3 1/8"	80 x 80
	3 1/2" x 3 1/2"	89 x 89
	-	90 x 90
	4" x 4"	100 x 100
	4 3/4" x 4 3/4"	120 x 120
	5" x 5"	125 x 125
	6" x 6"	150 x 150
	8" x 8"	200 x 200
	10" x 10"	250 x 250
	12" x 12"	300 x 300

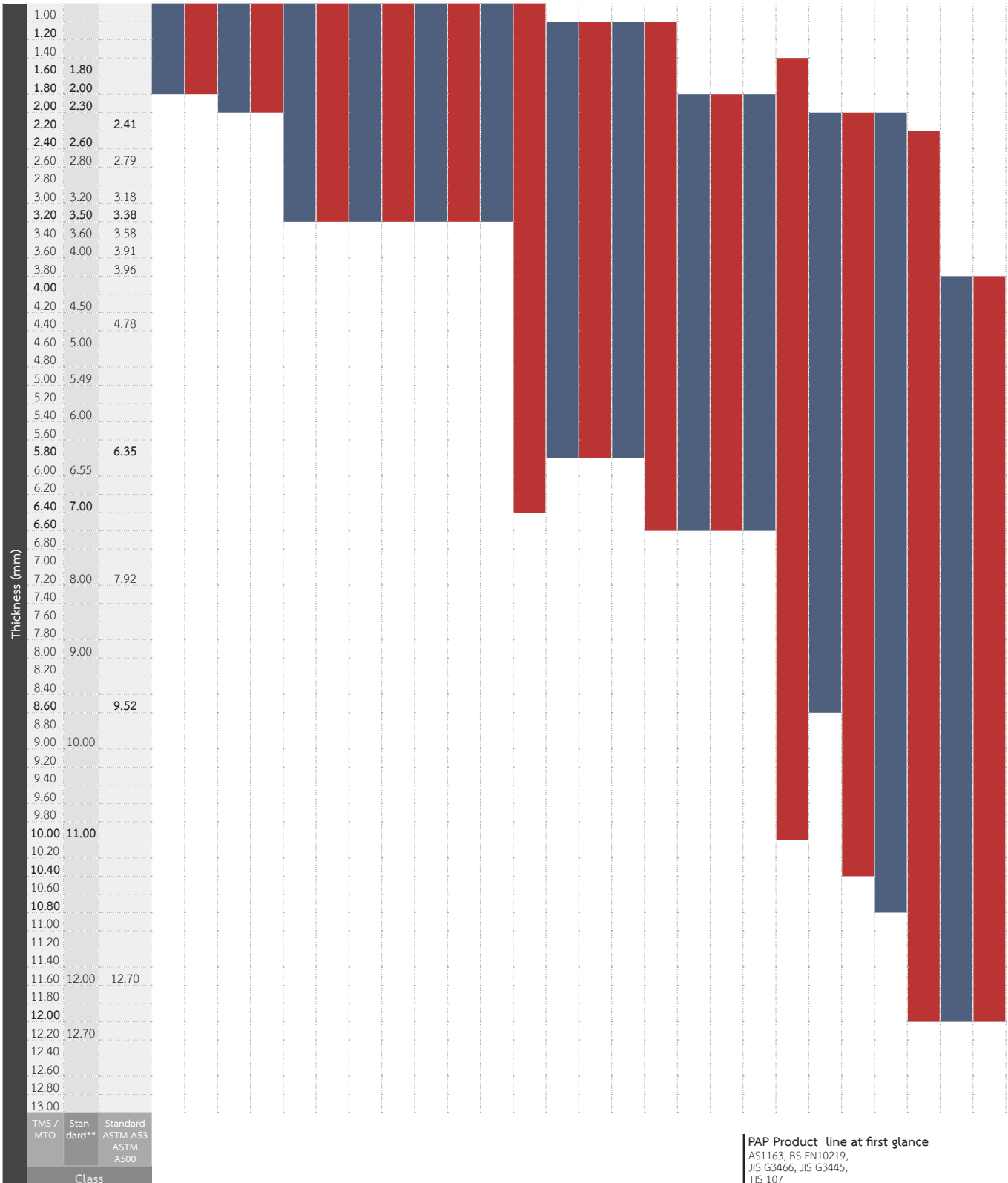

PAP Product line at first glance
 AS1163, BS EN10219,
 JIS G3466, JIS G3445,
 TIS 107

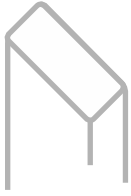

Production Capacity

Rectangular Pipe

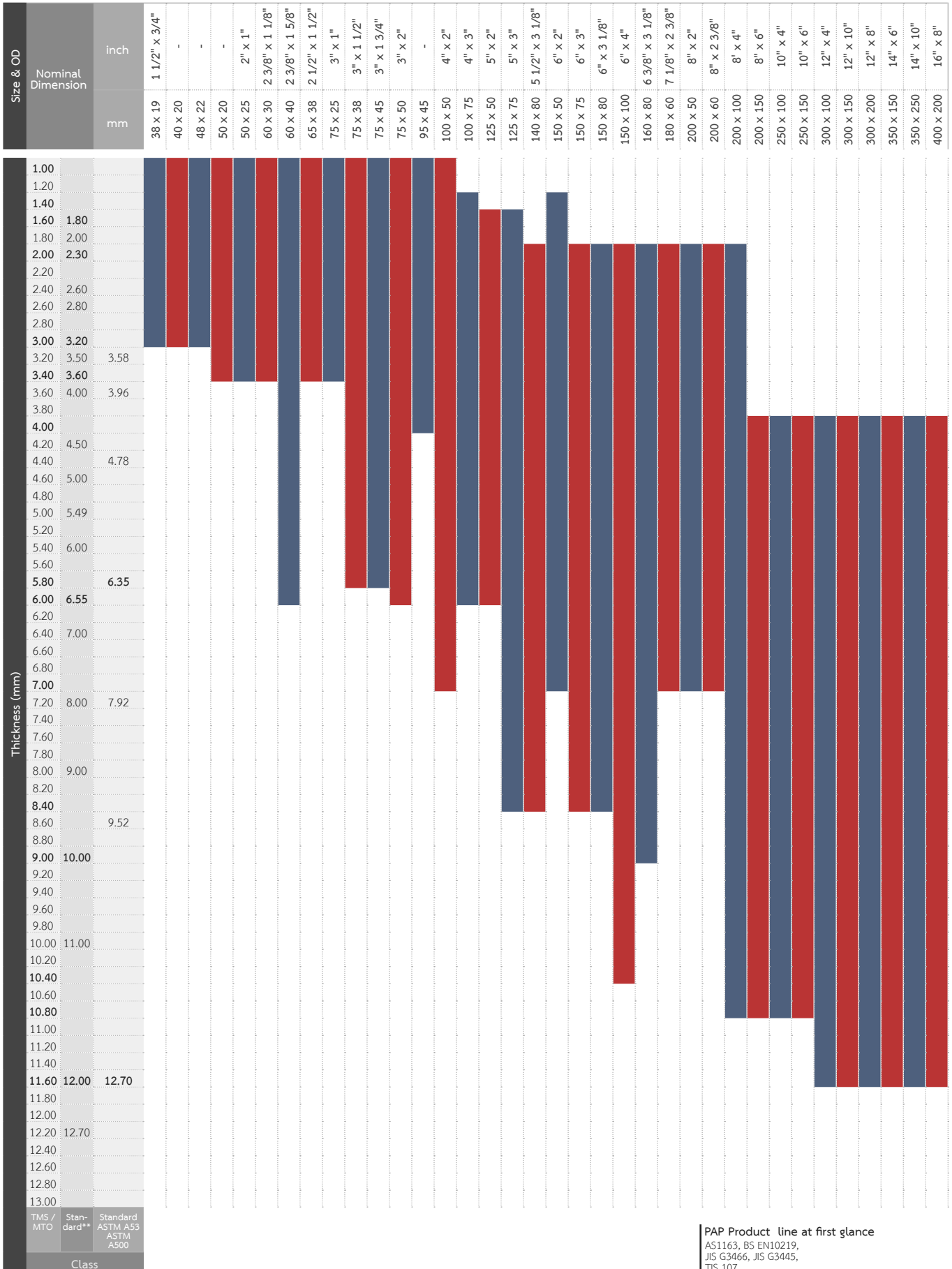

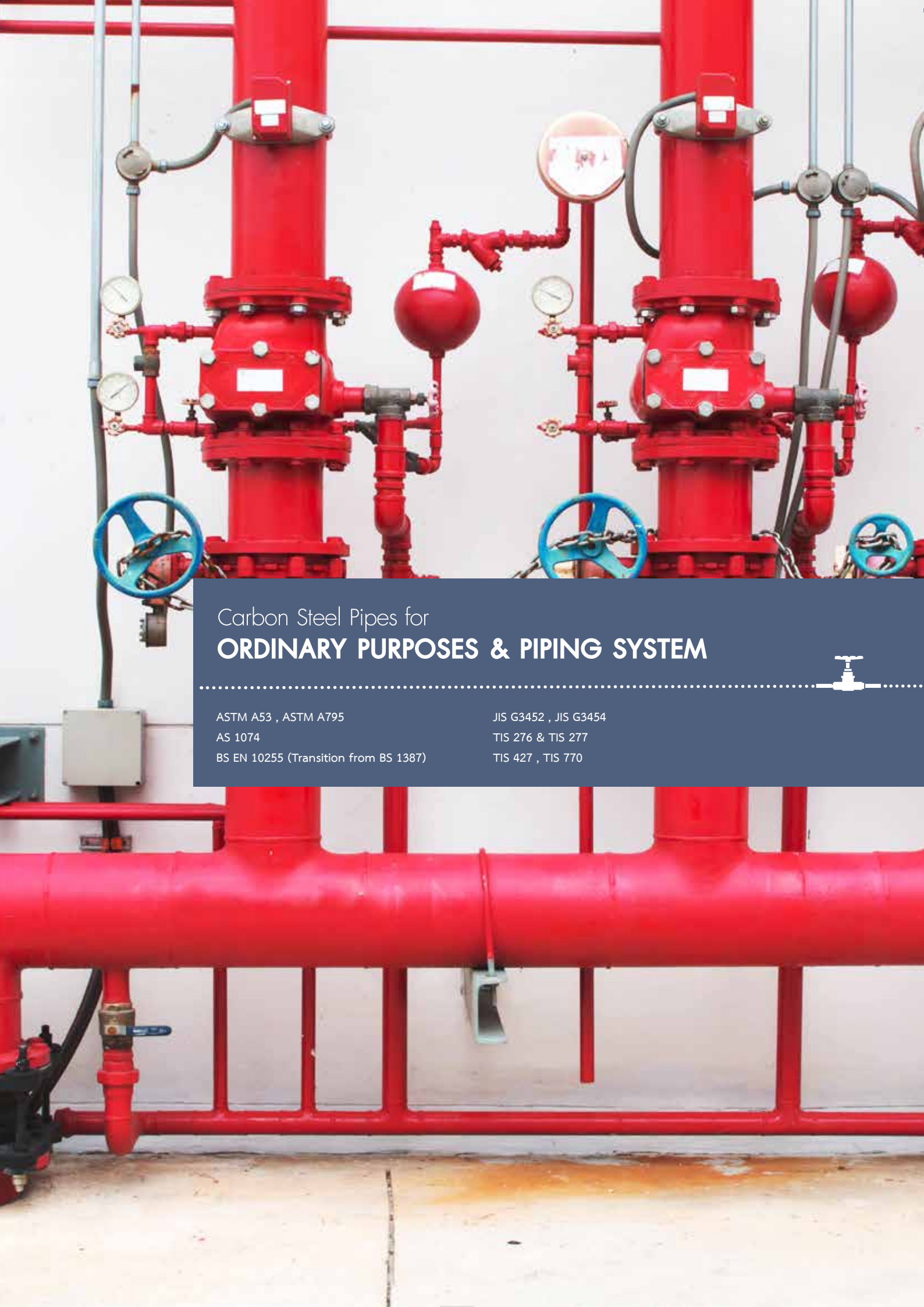

Carbon Steel Pipes for
ORDINARY PURPOSES & PIPING SYSTEM



ASTM A53 , ASTM A795
AS 1074
BS EN 10255 (Transition from BS 1387)

JIS G3452 , JIS G3454
TIS 276 & TIS 277
TIS 427 , TIS 770



Carbon Steel Pipes for Mechanical and Pressure Applications

Grade	% Chemical Composition (Max)										Mechanical Properties (Min)		
	C	Si	Mn	P	S	Cu	Ni	Cr	Mo	V	Yield Strength	Tensile Strength	Elongation
											MPa	MPa	%
Grade A	0.25	-	0.95	0.05	0.045	0.40	0.40	0.40	0.15	0.08	205	330	As Per Standard
Grade B	0.30	-	1.20	0.05	0.045	0.40	0.40	0.40	0.15	0.08	240	415	As Per Standard

Nominal Size		Outside Diameter	Thickness	Weight (plain end)	Hydrostatic Test Pressure				Schedule
mm	inch	mm	mm	kg/m	Grade A		Grade B		
					psi	kPa	psi	kPa	
15	1/2"	21.30	2.77	1.27	700	4800	700	4800	40
			3.73	1.62	850	5900	850	5900	80
20	3/4"	26.70	2.87	1.69	700	4800	700	4800	40
			3.91	2.20	850	5900	850	5900	80
25	1"	33.40	3.38	2.50	700	4800	700	4800	40
			4.55	3.24	850	5900	850	5900	80
32	1 1/4"	42.20	3.56	3.39	1200	8300	1300	9000	40
			4.85	4.47	1800	12400	1900	13100	80
40	1 1/2"	48.30	3.68	4.05	1200	8300	1300	9000	40
			5.08	5.41	1800	12400	1900	13100	80
50	2"	60.30	3.91	5.44	2300	15900	2500	17200	40
			5.54	7.48	2500	17200	2500	17200	80
65	2 1/2"	73.00	5.16	8.63	2500	17200	2500	17200	40
			7.01	11.41	2500	17200	2500	17200	80
80	3"	88.90	5.49	11.29	2220	15300	2500	17200	40
			7.62	15.27	2500	17200	2500	17200	80
90	3 1/2"	101.60	5.74	13.57	2030	14000	2370	16300	40
			8.08	18.63	2800	19300	2800	19300	80
100	4"	114.30	6.02	16.07	1900	13100	2210	15200	40
			8.56	22.32	2700	18600	2800	19300	80
125	5"	141.30	6.55	21.77	1670	11500	1950	13400	40
			9.52	30.94	2430	16800	2800	19300	80
150	6"	168.30	7.11	28.26	1520	10500	1780	12300	40
			10.97	42.56	2350	16200	2740	18900	80
200	8"	219.10	6.35	33.31	1040	7200	1220	8400	20
			7.04	36.31	1160	7800	1350	9300	30
			8.18	42.55	1340	9200	1570	10800	40
			10.31	53.08	1700	11700	2000	13800	60
			12.70	64.64	2090	14400	2430	16800	80
250	10"	273.00	6.35	41.75	840	5800	980	6800	20
			7.80	51.01	1030	7100	1200	8300	30
			9.27	60.29	1220	8400	1430	9900	40
300	12"	323.80	6.35	49.71	710	4900	820	5700	20
			8.38	65.18	930	6400	1090	7500	30
			10.31	79.70	1150	7900	1340	9200	40
350	14"	355.60	6.35	54.69	640	4400	750	5200	10
			7.92	67.90	800	5500	940	6500	20
			9.52	81.25	960	6600	1120	7700	30
			11.13	94.55	1130	7800	1310	9000	40
400	16"	406.40	6.35	62.64	560	3900	660	4500	10
			7.92	77.83	700	4800	820	5700	20
			9.52	93.17	840	5800	980	6800	30
			12.70	123.30	1120	7700	1310	9000	40

Dimension Tolerances	Outside Diameter	Thickness	Weight
	NPS ≤ 1 1/2 in (40 mm) : ±0.016 in (0.41 mm) NPS ≥ 2 in (50 mm) : ±1% from specified OD	-12.5 % , +Not Limit	±10%

ASTM A53

FiGuard-40
Carbon Steel Pipes for Fire Protection Use



Grade	% Chemical Composition (Max)										Mechanical Properties (Min)		
	C	Si	Mn	P	S	Cu	Ni	Cr	Mo	V	Yield Strength	Tensile Strength	Elongation
											MPa	MPa	%
Grade A	0.25	-	0.95	0.05	0.045	0.40	0.40	0.40	0.15	0.08	205	330	As Per Standard
Grade B	0.30	-	1.20	0.05	0.045	0.40	0.40	0.40	0.15	0.08	240	415	As Per Standard

Nominal Size		Outside Diameter	Thickness	Weight (plain end)	Rated Working Pressure	Hydrostatic Test Pressure				Schedule
mm	inch	mm	mm	kg/m	psi	Grade A		Grade B		
						psi	kPa	psi	kPa	
25	1"	33.40	3.38	2.50	300	1200	8300	1200	8300	40
32	1 1/4"	42.20	3.56	3.39	300	1200	8300	1300	9000	40
40	1 1/2"	48.30	3.68	4.05	300	1200	8300	1300	9000	40
50	2"	60.30	3.91	5.44	300	2300	15900	2500	17200	40
65	2 1/2"	73.00	5.16	8.63	300	2500	17200	2500	17200	40
80	3"	88.90	5.49	11.29	300	2220	15300	2500	17200	40
90	3 1/2"	101.60	5.74	13.57	300	2030	14000	2370	16300	40
100	4"	114.30	6.02	16.07	300	1900	13100	2210	15200	40
125	5"	141.30	6.55	21.77	300	1670	11500	1950	13400	40
150	6"	168.30	7.11	28.26	300	1520	10500	1780	12300	40
200	8"	219.10	8.18	42.55	300	1340	9200	1570	10800	40
250	10"	273.00	9.27	60.29	300	1220	8400	1430	9900	40
300	12"	323.80	10.31	79.70	300	1150	8300	1340	9200	40

Dimension Tolerances	Outside Diameter	Thickness	Weight	Length
	NPS ≤ 1 1/2 in (40 mm) NPS ≥ 2 in (50 mm)	: ±0.016 in (0.41 mm) : ±1% from specified OD	-12.5 % , +Not Limit	±10% -0 mm , + 50 mm

ASTM A53

Metallic Sprinkler Pipe for Fire Protection Service



Nominal Size		Outside Diameter	Thickness	Weight (plain end)	Hydrostatic Test Pressure (Grade A, B)				Schedule
mm	inch	mm	mm	kg/m	for 1 minute		for 5 seconds		
					psi	kPa	psi	kPa	
15	1/2"	21.30	2.77	1.27	600	4100	1200	8300	40
20	3/4"	26.70	2.87	1.69	600	4100	1200	8300	40
25	1"	33.40	3.38	2.50	600	4100	1200	8300	40
32	1 1/4"	42.20	3.56	3.39	600	4100	1200	8300	40
40	1 1/2"	48.30	3.68	4.05	600	4100	1200	8300	40
50	2"	60.30	3.91	5.44	600	4100	1200	8300	40
65	2 1/2"	73.00	5.16	8.63	600	4100	1200	8300	40
80	3"	88.90	5.49	11.29	600	4100	1200	8300	40
90	3 1/2"	101.60	5.74	13.57	600	4100	1200	8300	40
100	4"	114.30	6.02	16.07	600	4100	1200	8300	40
125	5"	141.30	6.55	21.77	600	4100	1200	8300	40
150	6"	168.30	7.11	28.26	600	4100	1200	8300	40
200	8"	219.10	8.18	42.55	600	4100	1200	8300	40

Dimension Tolerances	Outside Diameter	Thickness	Weight
	NPS ≤ 1 1/2 in (40 mm) NPS ≥ 2 in (50 mm)	: ±0.016 in (0.41 mm) : ±1% from specified OD	-12.5 % , +Not Limit ±10%



FiGuard-10

Carbon Steel Pipes for Fire Protection Use

ASTM A795

Grade	% Chemical Composition (Max)					Mechanical Properties (Min)		
	C	Si	Mn	P	S	Yield Strength	Tensile Strength	Elongation
						MPa	MPa	%
Grade A	0.25	-	0.95	0.035	0.035	-	-	-
Grade B	0.30	-	1.20	0.035	0.035	-	-	-

Nominal Size		Outside Diameter	Thickness	Weight (plain end)	Rated Working Pressure	Hydrostatic Test Pressure		Schedule
mm	inch	mm	mm	kg/m	psi	Grade A,B		
						psi	kPa	
25	1"	33.40	2.77	2.09	300	1200	8300	10
32	1 1/4"	42.20	2.77	2.69	300	1200	8300	10
40	1 1/2"	48.30	2.77	3.11	300	1200	8300	10
50	2"	60.30	2.77	3.93	300	1200	8300	10
65	2 1/2"	73.00	3.05	5.26	300	1200	8300	10
80	3"	88.90	3.05	6.46	300	1200	8300	10
90	3 1/2"	101.60	3.05	7.41	300	1200	8300	10
100	4"	114.30	3.05	8.37	300	1200	8300	10
125	5"	141.30	3.40	11.58	300	1200	8300	10
150	6"	168.30	3.40	13.85	300	1200	8300	10
200	8"	219.10	4.78	25.26	225	900	6200	10
250	10"	273.10	4.78	31.62	225	900	6200	10

Dimension Tolerances	Outside Diameter	Thickness	Weight	Length
	NPS ≤ 1 1/2 in (40 mm) NPS ≥ 2 in (50 mm)	: ±0.016 in (0.41 mm) : ±1% from specified OD	-12.5 % , +Not Limit	±5%

Remark : Schedule 10 corresponds to Schedule 10S as listed in ANSI B36.19 for NPS through 6 [DN 20 through 150] only

AS 1074

Steel Tubes and Tubulars for Ordinary Service

Grade	% Chemical Composition (Max)						Mechanical Properties (Min)			Class	Marking Color
	C	Si	Mn	P	S	CE*	Yield Strength	Tensile Strength	Elongation		
							MPa	MPa	%		
-	-	-	-	0.045	0.045	0.4	195	320-460	20	Light	Brown
										Medium	Blue
										Heavy	Red

*Carbon Equivalent, CE Where CE = C + Mn/6

Light Class								Hydrostatic Test Pressure
Nominal Size		Outside Diameter		Thickness	Mass of Black Tube			
mm	inch	Max mm	Min mm		Plain or Screwed Ends	Screwed and Socketed		
					kg/m	kg/m		
8	1/4"	13.6	13.2	1.8	0.515	0.519	5 MPa, Not specified duration for the test	
10	3/8"	17.1	16.7	1.8	0.670	0.676		
15	1/2"	21.4	21.0	2.0	0.947	0.956		
20	3/4"	26.9	26.4	2.3	1.38	1.39		
25	1"	33.8	33.2	2.6	1.98	2.00		
32	1 1/4"	42.5	41.9	2.6	2.54	2.57		
40	1 1/2"	48.4	47.8	2.9	3.23	3.27		
50	2"	60.2	59.6	2.9	4.08	4.15		
65	2 1/2"	76.0	75.2	3.2	5.71	5.83		
80	3"	88.7	87.9	3.2	6.72	6.89		
100	4"	113.9	113.0	3.6	9.75	10.0		

Medium Class								Hydrostatic Test Pressure
Nominal Size		Outside Diameter		Thickness	Mass of Black Tube			
mm	inch	Max mm	Min mm		Plain or Screwed Ends	Screwed and Socketed		
					kg/m	kg/m		
8	1/4"	13.9	13.3	2.3	0.641	0.645	5 MPa, Not specified duration for the test	
10	3/8"	17.4	16.8	2.3	0.839	0.845		
15	1/2"	21.7	21.1	2.6	1.21	1.22		
20	3/4"	27.2	26.6	2.6	1.56	1.57		
25	1"	34.2	33.4	3.2	2.41	2.43		
32	1 1/4"	42.9	42.1	3.2	3.10	3.13		
40	1 1/2"	48.8	48.0	3.2	3.57	3.61		
50	2"	60.8	59.8	3.6	5.03	5.10		
65	2 1/2"	76.6	75.4	3.6	6.43	6.55		
80	3"	89.5	88.1	4.0	8.37	8.54		
100	4"	114.9	113.3	4.5	12.2	12.5		
125	5"	140.6	138.7	5.0	16.6	17.1		
150	6"	166.1	164.1	5.0	19.7	20.3		

Heavy Class								Hydrostatic Test Pressure
Nominal Size		Outside Diameter		Thickness	Mass Per Unit Length			
mm	inch	Max mm	Min mm		Plain or Screwed Ends	Screwed and Socketed		
					kg/m	kg/m		
8	1/4"	13.9	13.3	2.9	0.765	0.769	5 MPa, Not specified duration for the test	
10	3/8"	17.4	16.8	2.9	1.02	1.030		
15	1/2"	21.7	21.1	3.2	1.44	1.45		
20	3/4"	27.2	26.6	3.2	1.87	1.88		
25	1"	34.2	33.4	4.0	2.94	2.96		
32	1 1/4"	42.9	42.1	4.0	3.80	3.83		
40	1 1/2"	48.8	48.0	4.0	4.38	4.42		
50	2"	60.8	59.8	4.5	6.19	6.26		
65	2 1/2"	76.6	75.4	4.5	7.93	8.05		
80	3"	89.5	88.1	5.0	10.3	10.5		
100	4"	114.9	113.3	5.4	14.5	14.8		
125	5"	140.6	138.7	5.4	17.9	18.4		
150	6"	166.1	164.1	5.4	21.3	21.9		

Dimension Tolerances	Thickness	Weight	Straightness	Length	Surface Finishes	Black, Galvanized HDG, Red Primed
	Light : -8%, +Not limit Medium : -10%, +Not limit Heavy : -10%, +Not limit	Single Tube -8%, +10%	0.2% of the length	-0 mm, +8 mm	End Finishes	Plain End, Screwed Ends, Screwed and Socketed



PSB Singapore

Carbon Steel Tubes (Transition from BS 1387)

BS EN 10255

Grade		% Chemical Composition (Max)					Mechanical Properties (Min)		
		C	Si	Mn	P	S	Yield Strength	Tensile Strength	Elongation
Steel Name	Steel Number						MPa	MPa	%
S 195T	1.0026	0.20	-	1.40	0.035	0.030	195	320 - 520	20

H Series							
Nominal Size	Specified Outside Diameter	Designation of Thread	Outside Diameter		Thick-ness	Mass Per Unit Length	
			Max	Min		Plain End	Threads & Couplings
mm	mm		mm	mm	mm	kg/m	kg/m
6	10.2	1/8	10.6	9.8	2.6	0.487	0.490
8	13.5	1/4	14.0	13.2	2.9	0.765	0.769
10	17.2	3/8	17.5	16.7	2.9	1.02	1.03
15	21.3	1/2	21.8	21.0	3.2	1.44	1.45
20	26.9	3/4	27.3	26.5	3.2	1.87	1.88
25	33.7	1	34.2	33.3	4.0	2.93	2.95
32	42.4	1 1/4	42.9	42.0	4.0	3.79	3.82
40	48.3	1 1/2	48.8	47.9	4.0	4.37	4.41
50	60.3	2	60.8	59.7	4.5	6.19	6.26
65	76.1	2 1/2	76.6	75.3	4.5	7.93	8.05
80	88.9	3	89.5	88.0	5.0	10.3	10.5
100	114.3	4	115.0	113.1	5.4	14.5	14.8
125	139.7	5	140.8	138.5	5.4	17.9	18.4
150	165.1	6	166.5	163.9	5.4	21.3	21.9

Type L							
Nominal Size	Specified Outside Diameter	Designation of Thread	Outside Diameter		Thick-ness	Mass Per Unit Length	
			Max	Min		Plain End	Threads & Couplings
mm	mm		mm	mm	mm	kg/m	kg/m
8	13.5	1/4	13.9	13.2	2.0	0.567	0.571
10	17.2	3/8	17.4	16.7	2.0	0.750	0.756
15	21.3	1/2	21.7	21.0	2.3	1.08	1.09
20	26.9	3/4	27.1	26.4	2.3	1.40	1.41
25	33.7	1	34.0	33.2	2.9	2.20	2.22
32	42.4	1 1/4	42.7	41.9	2.9	2.82	2.85
40	48.3	1 1/2	48.6	47.8	2.9	3.25	3.29
50	60.3	2	60.7	59.6	3.2	4.51	4.58
65	76.1	2 1/2	76.0	75.2	3.2	5.75	5.87
80	88.9	3	88.7	87.9	3.2	6.76	6.93
90	101.6	3 1/2	101.2	100.3	3.6	8.70	8.88
100	114.3	4	113.9	113.0	3.6	9.83	10.1
125	139.7	5	140.8	138.5	4.5	15.0	15.5
150	165.1	6	166.5	163.9	4.5	17.8	18.4

M Series							
Nominal Size	Specified Outside Diameter	Designation of Thread	Outside Diameter		Thick-ness	Mass Per Unit Length	
			Max	Min		Plain End	Threads & Couplings
mm	mm		mm	mm	mm	kg/m	kg/m
6	10.2	1/8	10.6	9.8	2.0	0.404	0.407
8	13.5	1/4	14.0	13.2	2.3	0.641	0.645
10	17.2	3/8	17.5	16.7	2.3	0.839	0.845
15	21.3	1/2	21.8	21.0	2.6	1.21	1.22
20	26.9	3/4	27.3	26.5	2.6	1.56	1.57
25	33.7	1	34.2	33.3	3.2	2.41	2.43
32	42.4	1 1/4	42.9	42.0	3.2	3.10	3.13
40	48.3	1 1/2	48.8	47.9	3.2	3.56	3.60
50	60.3	2	60.8	59.7	3.6	5.03	5.10
65	76.1	2 1/2	76.6	75.3	3.6	6.42	6.54
80	88.9	3	89.5	88.0	4.0	8.36	8.53
100	114.3	4	115.0	113.1	4.5	12.2	12.5
125	139.7	5	140.8	138.5	5.0	16.6	17.1
150	165.1	6	166.5	163.9	5.0	19.8	20.4

Type L 1							
Nominal Size	Specified Outside Diameter	Designation of Thread	Outside Diameter		Thick-ness	Mass Per Unit Length	
			Max	Min		Plain End	Threads & Couplings
mm	mm		mm	mm	mm	kg/m	kg/m
8	13.5	1/4	13.9	13.2	2.0	0.570	0.574
10	17.2	3/8	17.4	16.7	2.0	0.742	0.748
15	21.3	1/2	21.7	21.0	2.3	1.08	1.09
20	26.9	3/4	27.1	26.4	2.3	1.39	1.40
25	33.7	1	34.0	33.2	2.9	2.20	2.22
32	42.4	1 1/4	42.7	41.9	2.9	2.82	2.85
40	48.3	1 1/2	48.6	47.8	2.9	3.24	3.28
50	60.3	2	60.7	59.6	3.2	4.49	4.56
65	76.1	2 1/2	76.3	75.2	3.2	5.73	5.85
80	88.9	3	89.4	87.9	3.6	7.55	7.72
100	114.3	4	114.9	113.0	4.0	10.80	11.10

Type L 2							
Nominal Size	Specified Outside Diameter	Designation of Thread	Outside Diameter		Thick-ness	Mass Per Unit Length	
			Max	Min		Plain End	Threads & Couplings
mm	mm		mm	mm	mm	kg/m	kg/m
8	13.5	1/4	13.6	13.2	1.8	0.515	0.519
10	17.2	3/8	17.1	16.7	1.8	0.670	0.676
15	21.3	1/2	21.4	21.0	2.0	0.947	0.956
20	26.9	3/4	26.9	26.4	2.3	1.38	1.39
25	33.7	1	33.8	33.2	2.6	1.98	2.00
32	42.4	1 1/4	42.5	41.9	2.6	2.54	2.57
40	48.3	1 1/2	48.4	47.8	2.9	3.23	3.27
50	60.3	2	60.2	59.6	2.9	4.08	4.15
65	76.1	2 1/2	76.0	75.2	3.2	5.71	5.83
80	88.9	3	88.7	87.9	3.2	6.72	6.89
100	114.3	4	113.9	113.0	3.6	9.75	10.00

Series / Type	H Series	M Series	Type L	Type L1	Type L2
Marking Color	Red	Blue	Green	White	Brown

Dimension Tolerances	Thickness	M, H Series and Type L : $\pm 10\%$ Type L1, L2 : + by mass tolerance, -8%
	Weight	M, H Series and Type L : $\pm 7.5\%$ Type L1, L2 : +10% , -8% on individual tubes
	Hydrostatic Test	50 bar



JIS G3452

Carbon Steel Pipes for Ordinary Piping



Grade	% Chemical Composition (Max)					Mechanical Properties (Min)			Marking Color
	C	Si	Mn	P	S	Yield Strength	Tensile Strength	Elongation	
						MPa	MPa	%	
SGP	-	-	-	0.04	0.04	-	290	19 - 25 up to wall thickness	White

Nominal Size		Outside Diameter		Thickness	Weight (plain end)
		mm			
mm	inch	STD	Tolerances	mm	kg/m
15	1/2"	21.7	±0.50	2.8	1.31
20	3/4"	27.2	±0.50	2.8	1.68
25	1"	34.0	±0.50	3.2	2.43
32	1 1/4"	42.7	±0.50	3.5	3.38
40	1 1/2"	48.6	±0.50	3.5	3.89
50	2"	60.5	±0.50	3.8	5.31
65	2 1/2"	76.3	±0.70	4.2	7.47
80	3"	89.1	±0.80	4.2	8.79
90	3 1/2"	101.6	±0.80	4.2	10.10
100	4"	114.3	±0.80	4.5	12.20
125	5"	139.8	±0.80	4.5	15.00
150	6"	165.2	±0.80	5.0	19.80
175	7"	190.7	±0.90	5.3	24.20
200	8"	216.3	±1.00	5.8	30.10
225	9"	241.8	±1.20	6.2	36.00
250	10"	267.4	±1.30	6.6	42.40
300	12"	318.5	±1.50	6.9	53.00
350	14"	355.6	-	7.9	67.70
400	16"	406.4	-	7.9	77.60

Dimension Tolerances	Thickness	Hydrostatic Test Pressure
	-12.5 % , +Not Limit	2.5 MPa



JIS G3454

Carbon Steel Pipes for Pressure Service

Grade	% Chemical Composition (Max)					Mechanical Properties (Min)			Marking Color
	C	Si	Mn	P	S	Yield Strength	Tensile Strength	Elongation	
						MPa	MPa	%	
STPG370	0.25	0.35	0.30 - 0.90	0.04	0.04	215	370	30	White
STPG410	0.30	0.35	0.30 - 1.00	0.04	0.04	245	410	25	White

Nominal Size		Outside Diameter	Thickness	Weight (plain end)	Hydrostatic Test Pressure
mm	inch	mm	mm	kg/m	Schedule 40
					bar
15	1/2"	21.70	2.80	1.31	60
20	3/4"	27.20	2.90	1.74	60
25	1"	34.00	3.40	2.57	60
32	1 1/4"	42.70	3.60	3.47	60
40	1 1/2"	48.60	3.70	4.10	60
50	2"	60.50	3.90	5.44	60
65	2 1/2"	76.30	5.20	9.12	60
80	3"	89.10	5.50	11.30	60
90	3 1/2"	101.60	5.70	13.50	60
100	4"	114.30	6.00	16.00	60
125	5"	139.80	6.60	21.70	60
150	6"	165.20	7.10	27.70	60
200	8"	216.30	8.20	42.10	60
250	10"	267.40	9.30	59.20	60
300	12"	318.50	10.30	78.30	60
350	14"	355.60	11.10	94.30	60
400	16"	406.40	12.70	123.00	60

Dimension Tolerances	Outside Diameter	Thickness
	DN ≤ 25 mm : ±0.3 mm DN ≥ 32 mm : ±0.8% DN ≥ 350 mm : ±0.5%	t < 3.00 mm : ±0.30 mm t ≥ 3.00 mm : ±10%



Grade	% Chemical Composition (Max)					Mechanical Properties (Min)			Hydrostatic Test	Class	Marking Color
	C	Si	Mn	P	S	Yield Strength	Tensile Strength	Elongation			
						MPa	MPa	%	Bar		
-	-	-	-	-	-	-	320	20	50	Type 1	Brown
										Type 2	Blue
										Type 3	Red
										Type 4	Green

Nominal Size		Outside Diameter		Thickness	Weight (plain end)	Threads Per inch
mm	inch	Max mm	Min mm			
15	1/2"	21.40	21.00	2.00	0.95	14
20	3/4"	26.90	26.40	2.30	1.38	14
25	1"	33.80	33.20	2.60	1.98	11
32	1 1/4"	42.50	41.90	2.60	2.54	11
40	1 1/2"	48.40	47.80	2.90	3.23	11
50	2"	60.20	59.60	2.90	4.08	11
65	2 1/2"	76.00	75.20	3.20	5.71	11
80	3"	88.70	87.90	3.20	6.72	11
100	4"	113.90	113.00	3.60	9.75	11

Nominal Size		Outside Diameter		Thickness	Weight (plain end)	Threads Per inch
mm	inch	Max mm	Min mm			
15	1/2"	21.80	21.00	3.20	1.44	14
20	3/4"	27.30	26.50	3.20	1.87	14
25	1"	34.20	33.30	4.00	2.93	11
32	1 1/4"	42.90	42.00	4.00	3.79	11
40	1 1/2"	48.80	47.90	4.00	4.37	11
50	2"	60.80	59.70	4.50	6.19	11
65	2 1/2"	76.60	75.30	4.50	7.93	11
80	3"	89.50	88.00	5.00	10.30	11
100	4"	115.00	113.10	5.40	14.50	11
125	5"	140.80	138.50	5.40	17.90	11
150	6"	166.50	163.90	5.40	21.30	11

Nominal Size		Outside Diameter		Thickness	Weight (plain end)	Threads Per inch
mm	inch	Max mm	Min mm			
15	1/2"	21.80	21.00	2.60	1.21	14
20	3/4"	27.30	26.50	2.60	1.56	14
25	1"	34.20	33.30	3.20	2.41	11
32	1 1/4"	42.90	42.00	3.20	3.10	11
40	1 1/2"	48.80	47.90	3.20	3.56	11
50	2"	60.80	59.70	3.60	5.03	11
65	2 1/2"	76.60	75.30	3.60	6.42	11
80	3"	89.50	88.00	4.00	8.36	11
100	4"	115.00	113.10	4.50	12.20	11
125	5"	140.80	138.50	5.00	16.60	11
150	6"	166.50	163.90	5.00	19.80	11

Nominal Size		Outside Diameter		Thickness	Weight (plain end)	Threads Per inch
mm	inch	Max mm	Min mm			
65	2 1/2"	73.70	72.30	5.20	8.60	8
80	3"	89.80	88.00	5.50	11.30	8
100	4"	115.40	113.20	6.00	16.10	8
125	5"	142.70	139.90	6.60	21.80	8
150	6"	170.00	166.60	7.10	28.30	8
200 (n)	8"	221.30	216.90	7.00	36.80	8
200 (n)	8"	221.30	216.90	8.20	42.50	8

Dimension Tolerances	Thickness	Weight
	Type 1, 2 Type 3, 4	: -8% , +Not Limit : -12.5 % , +Not Limit



Electrically Welded Steel Pipe for Water Supply

TIS 427

Class	% Chemical Composition (Max)						Mechanical Properties (Min)		
	C	Si	Mn	P	S	Cu	Yield Strength	Tensile Strength	Elongation
							MPa	MPa	%
Class n	0.250	-	-	0.040	0.050	0.20	165	310 - 380	27
Class u	0.250	-	-	0.040	0.050	0.20	205	380 - 450	22
Class k	0.300	-	-	0.040	0.050	0.20	230	≥415	20

Nominal Size		Outside Diameter	Thickness	Weight (plain end)	Hydrostatic Test Pressure		
mm	inch	mm	mm	kg/m	MPa		
					Class n	Class u	Class k
100	4"	101.6	2.70	6.585	5.26	6.54	7.33
			3.45	8.351	6.72	8.35	9.37
115	4 1/2"	114.3	2.70	7.431	4.68	5.81	6.52
			3.45	9.431	5.98	7.43	8.33
150 A	6"	152.4	2.70	9.970	4.38	5.45	6.11
			3.45	12.67	5.60	6.96	7.81
			4.80	17.47	7.80	9.69	10.87
			5.50	19.93	8.93	11.10	12.45
150	6 5/8"	168.3	2.70	11.03	3.97	4.93	5.53
			3.45	14.03	5.07	6.30	7.07
			4.80	19.35	7.06	8.77	9.84
			5.50	22.08	8.09	10.05	11.27
200 A	8"	203.0	3.45	16.98	4.21	5.23	5.86
			4.50	22.03	5.49	6.82	7.65
			4.80	23.46	5.85	7.27	8.16
			6.00	29.15	7.32	9.09	10.20
200	8 5/8"	219.1	3.45	18.35	3.90	4.84	5.43
			4.50	23.82	5.08	6.32	7.09
			4.80	25.37	5.42	6.74	7.56
			6.00	31.53	6.78	8.42	9.45
250 A	10"	254.0	3.45	21.32	3.81	4.73	5.31
			4.50	27.69	4.97	6.17	6.93
			4.80	29.50	5.30	6.59	7.39
			6.00	36.70	6.63	8.23	9.24
250	10 3/4"	273.0	3.45	22.93	3.54	4.40	4.94
			4.50	29.80	4.62	5.74	6.45
			4.80	31.75	4.93	6.13	6.87
			6.00	39.51	6.16	7.66	8.59
300	12 3/4"	323.9	4.50	35.45	3.90	4.84	5.43
			4.80	37.77	4.16	5.16	5.79
			6.00	47.04	5.20	6.46	7.24
350	14"	355.6	4.80	41.53	3.79	4.70	5.28
			6.00	51.73	4.73	5.88	6.60
400	16"	406.4	4.80	47.54	3.31	4.12	4.62
			6.00	59.25	4.14	5.15	5.77
			6.35	62.65	4.38	5.45	6.11
			7.90	77.64	5.45	6.77	7.60

Dimension Tolerances	Outside Diameter	Thickness
	OD < 500 mm : ±1%	- 0.25 mm , +Not Limit



Type 1 : EMT (Electrical Metallic Tubing)						
Nominal Size		Outside Diameter		Thickness ¹⁾	Length	Minimum Mass of 10 Pieces ²⁾
mm	inch	mm		mm	mm	kg
15	1/2"	17.9	±0.2	1.07	3050 ±6	12.9
20	3/4"	23.4		1.24		19.7
25	1"	29.5		1.45		29.0
32	1 1/4"	38.4		1.65		43.1
40	1 1/2"	44.2		1.65		49.9
50	2"	55.8		1.65		63.5
65	2 1/2"	73.0	±0.3	1.83		93.0
80	3"	88.9	±0.4	1.83		113.0
90	3 1/2"	101.6	±0.5	2.11		147.0
100	4"	114.3		2.11		168.0

Type	Marking Color
EMT	Green
IMC	Orange
RSC	Black

Note :
 1) The pipe wall thickness shown is recommended size.
 2) The lowest mass of 10 pipes can be tested at the factory.

Type 2 : IMC (Intermediate Metallic Conduit)													
Nominal Size		Conduits					Coupling				Minimum Mass ²⁾ of 10 Pieces		
mm	inch	Outside Diameter	Thickness		Length Not Include Coupling		Outside Diameter	Minimum Length	Minimum Mass	kg	kg		
		mm	mm	mm	mm	mm	mm	mm	kg				
15	1/2"	20.7	±0.2	1.79	-0, +0.4	3030	+6	25.7	+Unlimit -0.4	41.3	0.052	25.4	
20	3/4"	26.1		1.90		3030		31.8		41.7	0.077	34.6	
25	1"	32.8		2.16		3025		38.7		50.0	0.136	49.9	
32	1 1/4"	41.6		2.16	3025	47.5		51.6	0.168	64.3			
40	1 1/2"	47.8		2.29	3025	54.7		52.4	0.234	79.1			
50	2"	59.9		2.41	3025	67.3		54.0	0.304	105.2			
65	2 1/2"	72.6	±0.3	3.56	-0, +0.5	3010		±6	82.6	+Unlimit -1%	81.0	0.760	186.2
80	3"	88.3		3.56		3010			98.3		84.1	0.946	229.0
90	3 1/2"	100.9		3.56		3005			111.1		86.5	1.157	263.0
100	4"	113.4		3.56		3005			123.8		89.3	1.288	296.1

Note :
 1) The measurement of the outer diameter of the connecting joint, when measured in millimeter, should be rounded to 1 decimal place.
 2) The lowest mass of 10 pipes can be tested at the factory.

Type 3 : RSC (Rigid Steel Conduit)													
Nominal Size		Conduits					Coupling				Minimum Mass ³⁾ of 10 Pieces		
mm	inch	Outside Diameter	Thickness		Length Not Include Coupling		Outside Diameter	Minimum Length	Minimum Mass	kg	kg		
		mm	mm	mm	mm	mm	mm	mm	kg				
15	1/2"	21.3	±0.4	2.64	-12.5%, +0	3030	±6	25.7	+Unlimit -0.4	41.3	0.052	35.8	
20	3/4"	26.7		2.72		3030		31.8		41.7	0.077	47.6	
25	1"	33.4		3.20		3025		38.7		50.0	0.136	69.4	
32	1 1/4"	42.2		3.38		3025		47.5	51.6	0.168	91.1		
40	1 1/2"	48.3		3.51		3025		54.7	52.4	0.234	113.0		
50	2"	60.3		3.71		3025		67.3	54.0	0.304	151.0		
65	2 1/2"	73.0	±0.6	4.90	+0	3010		±6	82.6	+Unlimit -1%	81.0	0.760	239.0
80	3"	88.9		5.21		3010			98.3		84.1	0.946	310.0
90	3 1/2"	101.6		5.46		3005			111.1		86.5	1.157	373.0
100	4"	114.3		5.72		3005			123.8		89.3	1.288	441.0
125	5"	141.3	±1.5	6.22	+0	3000	±6		152.4	+Unlimit -1%	100.0	2.024	596.0
150	6"	168.0		6.76		3000			182.9		108.0	3.303	792.0

Note :
 1) The measurement of the thickness of the pipe wall, when measured in millimeter, should be rounded to 2 decimal places.
 2) The measurement of the outer diameter of the connecting joint, when measured in millimeter, should be rounded to 1 decimal place.
 3) The lowest mass of 10 pipes can be tested at the factory.



Carbon Steel Pipes for
GENERAL STRUCTURE PURPOSES

ASTM A500
AS 1163
BS 1139

BS EN 10219
JIS G3444 , JIS G3466
TIS 107 , TIS 1228

Carbon Steel Round Pipe for General Structure

ASTM A500

Grade	% Chemical Composition (Max)						Mechanical Properties (Min)		
	C	Si	Mn	P	S	Cu	Yield Strength	Tensile Strength	Elongation
							Round	Round	Round
MPa	MPa	%							
Grade A	0.30	-	1.40	0.045	0.045	0.18	230	310	25
Grade B	0.30	-	1.40	0.045	0.045	0.18	290	400	23
Grade C	0.27	-	1.40	0.045	0.045	0.18	315	425	21
Grade D	0.30	-	1.40	0.045	0.045	0.18	250	400	23

Nominal Size		Outside Diameter	Thickness	Weight	Cross Sectional Area A	Geometrical Moment of Inertia I	Modulus of Section Z	Radius of Gyration i
mm	inch	mm	mm	kg/m	cm ²	cm ⁴	cm ³	cm
15	1/2"	21.30	2.77	1.27	1.618	0.708	0.664	0.661
20	3/4"	26.70	2.87	1.69	2.148	1.547	1.159	0.849
25	1"	33.40	2.64	2.00	2.551	3.040	1.820	1.092
			3.38	2.50	3.188	3.636	2.178	1.068
			4.55	3.24	4.124	4.397	2.633	1.033
32	1 1/4"	42.20	2.79	2.71	3.454	6.740	3.196	1.397
			3.56	3.39	4.323	8.137	3.856	1.372
			4.85	4.47	5.693	10.095	4.784	1.332
40	1 1/2"	48.30	2.90	3.25	4.138	10.705	4.433	1.608
			3.68	4.05	5.161	12.930	5.354	1.583
50	2"	60.30	3.07	4.33	5.522	22.672	7.520	2.026
			3.91	5.44	6.930	27.676	9.179	1.998
			5.54	7.48	9.534	36.104	11.975	1.946
65	2 1/2"	73.00	3.96	6.74	8.593	51.364	14.072	2.445
			4.78	8.04	10.249	59.913	16.415	2.418
			5.16	8.63	11.002	63.657	17.440	2.405
			7.01	11.41	14.539	80.031	21.926	2.346
80	3"	88.90	3.96	8.29	10.571	95.545	21.495	3.006
			4.78	9.92	12.637	112.140	25.228	2.979
			5.49	11.29	14.392	125.701	28.279	2.955
90	3 1/2"	101.60	3.96	9.53	12.152	145.053	28.554	3.455
			4.78	11.41	14.545	170.850	33.632	3.427
			5.74	13.57	17.293	199.349	39.242	3.395
100	4"	114.30	3.96	10.78	13.733	209.261	36.616	3.904
			4.78	12.91	16.453	247.155	43.247	3.876
			5.56	14.91	19.002	281.586	49.271	3.850
			6.02	16.07	20.487	301.173	52.699	3.834
125	5"	141.30	6.55	21.77	27.739	631.084	89.325	4.770
			9.53	30.97	39.467	861.079	121.880	4.671
150	6"	168.30	7.11	28.26	36.019	1172.095	139.286	5.704
			10.97	42.56	54.243	1686.484	200.414	5.576
200	8"	219.10	8.18	42.55	54.225	3019.910	275.665	7.463
			12.70	64.64	82.383	4403.608	401.972	7.311
250	10"	273.00	9.27	60.31	76.836	6688.508	490.001	9.330
			12.70	81.55	103.897	8820.505	646.191	9.214
300	12"	323.80	9.53	73.88	94.128	11631.494	718.437	11.116
			12.70	97.46	124.173	15047.403	929.426	11.008
350	14"	355.60	9.53	81.33	103.653	15529.184	873.407	12.240
			12.70	107.39	136.866	20143.557	1132.933	12.132
400	16"	406.40	9.53	93.27	118.868	23416.540	1152.389	14.036
			12.70	123.30	157.100	30478.000	1500.000	13.900

Dimension Tolerances	Outside Diameter	Thickness	Length
	NPS ≤ 1½ in : ±0.5% NPS ≥ 2 in : ±0.75%	±10 % of wall thickness	≤6.5 m : -6 mm, +13 mm >6.5 m : -6 mm, +19 mm

ASTM A500

Carbon Steel Square Pipe for General Structure

Grade	% Chemical Composition (Max)						Mechanical Properties (Min)		
	C	Si	Mn	P	S	Cu	Yield Strength	Tensile Strength	Elongation
							Shaped	Shaped	Shaped
MPa	MPa	%							
Grade A	0.30	-	1.40	0.045	0.045	0.18	270	310	25
Grade B	0.30	-	1.40	0.045	0.045	0.18	315	400	23
Grade C	0.27	-	1.40	0.045	0.045	0.18	345	425	21
Grade D	0.30	-	1.40	0.045	0.045	0.18	250	400	23

Nominal Size		Thickness	Weight	Cross Sectional Area A	Geometrical Moment of Inertia Ix , Iy	Modulus of Section Zx , Zy	Radius of Gyration Ix , Iy
mm	inch	mm	kg/m	cm ²	cm ⁴	cm ³	cm
25.4 x 25.4	1" x 1"	2.41	1.62	2.07	1.75	1.38	0.92
		3.38	2.10	2.68	2.04	1.60	0.87
50.8 x 50.8	2" x 2"	2.79	4.00	5.16	19.41	7.64	1.94
		3.18	4.52	5.80	21.40	8.42	1.92
		3.91	5.44	6.94	24.67	9.71	1.89
		4.78	6.41	8.21	27.88	10.97	1.84
63.5 x 63.5	2 1/2" x 2 1/2"	3.58	6.43	8.25	48.35	15.23	2.42
		4.78	8.32	10.64	59.36	18.70	2.36
		6.35	10.56	13.13	66.84	21.05	2.26
76.2 x 76.2	3" x 3"	3.96	8.60	11.04	94.20	24.72	2.92
		4.78	10.21	13.07	108.49	28.47	2.88
		6.35	13.09	16.36	126.31	33.15	2.78
89.9 x 89.9	3 1/2" x 3 1/2"	3.96	10.24	13.05	154.44	34.74	3.44
		4.78	12.11	15.50	179.16	40.31	3.40
		6.35	15.62	19.59	213.28	47.98	3.30
		7.92	18.88	23.50	242.68	54.60	3.21
101.6 x 101.6	4" x 4"	4.78	13.85	17.92	275.30	54.19	3.92
		6.35	17.89	22.81	332.96	65.54	3.82
		7.92	21.61	27.53	384.04	75.60	3.74
127.0 x 127.0	5" x 5"	4.78	17.65	22.78	559.65	88.13	4.96
		6.35	22.94	29.26	691.23	108.86	4.86
		7.92	27.93	35.57	811.65	127.82	4.78
152.4 x 152.4	6" x 6"	4.78	21.44	27.64	992.88	130.30	5.99
		6.35	28.00	35.71	1242.75	163.09	5.90
		7.92	34.25	43.62	1475.70	193.66	5.82
		9.52	40.28	51.30	1684.99	221.13	5.73
177.8 x 177.8	7" x 7"	4.78	25.07	32.49	1606.30	180.69	7.03
		6.35	32.80	42.17	2029.15	228.25	6.94
		7.92	39.16	51.67	2428.12	273.13	6.86
203.2 x 203.2	8" x 8"	6.35	37.85	48.62	3092.04	304.33	7.97
		7.92	46.49	59.71	3720.81	366.22	7.89
		9.52	54.80	70.65	4309.18	424.13	7.81
		12.70	70.46	89.86	5178.43	509.69	7.59
254.0 x 254.0	10" x 10"	6.35	47.96	61.52	6213.81	489.28	10.05
		7.92	59.13	75.81	7534.67	593.28	9.97
		9.52	69.98	89.99	8796.58	692.64	9.89
		12.70	90.69	115.67	10828.27	852.62	9.68

Dimension Tolerances	Outside Flat Dimension	Thickness	Length
	DN ≤ 2 1/2 in (65 mm) : ±0.020 in (0.50 mm) 2 1/2 in < DN ≤ 3 1/2 in (65-90mm) : ±0.025 in (0.60 mm) 3 1/2 in < DN ≤ 5 1/2 in (90-140 mm) : ±0.030 in (0.80 mm) 5 1/2 in (140 mm) < DN : 0.01 time large flat dimension	±10 % of wall thickness	≤6.5 m : -6 mm , +13 mm >6.5 m : -6 mm , +19 mm

Carbon Steel Rectangular Pipe for General Structure

ASTM A500

Grade	% Chemical Composition (Max)						Mechanical Properties (Min)		
	C	Si	Mn	P	S	Cu	Yield Strength	Tensile Strength	Elongation
							Shaped	Shaped	Shaped
MPa	MPa	%							
Grade A	0.30	-	1.40	0.045	0.045	0.18	270	310	25
Grade B	0.30	-	1.40	0.045	0.045	0.18	315	400	23
Grade C	0.27	-	1.40	0.045	0.045	0.18	345	425	21
Grade D	0.30	-	1.40	0.045	0.045	0.18	250	400	23

Nominal Size		Thickness	Weight	Cross Sectional Area A	Geometrical Moment of Inertia		Modulus of Section		Radius of Gyration	
mm	inch				ix	Iy	Zx	Zy	ix	Iy
mm	inch	mm	kg/m	cm ²	cm ⁴	cm ⁴	cm ³	cm ³	cm	cm
76.2 x 50.8	3" x 2"	3.58	6.43	8.25	63.01	33.42	16.54	13.16	2.76	2.01
		4.78	8.32	10.64	77.48	40.78	20.33	16.05	2.70	1.96
		6.35	10.56	13.13	86.86	45.72	22.80	18.00	2.57	1.87
101.6 x 50.8	4" x 2"	3.96	8.60	11.04	140.10	47.00	27.58	18.50	3.56	2.06
		4.78	10.21	13.07	161.40	53.68	31.77	21.13	3.51	2.03
		6.35	13.09	16.36	186.41	61.76	36.69	24.31	3.38	1.94
101.6 x 76.2	4" x 3"	3.96	10.24	13.05	188.08	120.47	37.02	31.62	3.80	3.04
		4.78	12.11	15.50	218.35	139.50	42.98	36.61	3.75	3.00
		6.35	15.62	19.59	259.68	165.77	51.12	43.51	3.64	2.91
127.0 x 76.2	5" x 3"	4.78	13.85	17.92	378.20	170.51	59.56	44.75	4.59	3.08
		6.35	17.89	22.81	456.23	205.22	71.85	53.86	4.47	3.00
		7.92	21.61	27.53	525.97	235.17	82.83	61.72	4.37	2.92
		9.52	25.06	31.96	581.13	258.44	91.52	67.83	4.26	2.84
152.4 x 76.2	6" x 3"	4.78	15.74	20.35	595.87	201.52	78.20	52.89	5.41	3.15
		6.35	20.42	26.04	726.36	244.68	95.32	64.22	5.28	3.07
		7.92	24.78	31.55	845.18	282.28	110.92	74.09	5.18	2.99
		9.52	28.85	36.79	943.43	312.56	123.81	82.04	5.06	2.91
152.4 x 101.6	6" x 4"	4.78	17.65	22.78	728.21	389.21	95.57	76.62	5.65	4.13
		6.35	22.94	29.26	898.49	479.51	117.91	94.39	5.54	4.05
		7.92	27.93	35.57	1055.35	561.00	138.50	110.43	5.54	3.97
		9.52	32.65	41.63	1190.62	630.55	156.25	124.12	5.35	3.89
203.2 x 101.6	8" x 4"	4.78	21.44	27.64	1475.06	503.11	145.18	99.04	7.31	4.27
		6.35	28.00	35.71	1841.61	626.05	181.26	123.24	7.18	4.19
		7.92	34.25	43.62	2185.69	737.97	215.13	145.27	7.08	4.11
		9.52	40.28	51.30	2493.58	836.30	245.43	164.63	6.97	4.04
203.2 x 152.4	8" x 6"	4.78	25.07	32.49	1953.15	1257.55	192.24	165.03	7.75	6.22
		6.35	32.80	42.17	2466.83	1587.01	242.80	208.27	7.65	6.13
		7.92	39.16	51.67	2953.25	1896.05	290.67	248.83	7.56	6.06
		9.52	47.21	60.97	3401.38	2179.36	334.78	286.01	7.47	5.98
		12.70	60.34	76.96	4006.04	2568.06	394.30	337.02	7.21	5.78
254.0 x 152.4	10" x 6"	6.35	37.85	48.62	4234.97	1931.27	333.46	253.45	9.33	6.30
		7.92	46.49	59.71	5097.46	2316.40	401.38	303.99	9.24	6.23
		9.52	54.80	70.65	5904.52	2673.74	464.92	350.88	9.14	6.15
		12.70	70.46	89.86	7068.32	3199.35	556.56	419.86	8.87	5.97

Dimension Tolerances	Outside Flat Dimension	Thickness	Length
	DN ≤ 2 ½ in (65 mm) : ±0.020 in (0.50 mm) 2 ½ in < DN ≤ 3 1/2 in (65-90mm) : ±0.025 in (0.60 mm) 3 ½ in < DN ≤ 5 1/2 in (90-140 mm) : ±0.030 in (0.80 mm) 5 ½ in (140 mm) < DN : 0.01 time large flat dimension	±10 % of wall thickness	≤6.5 m : -6 mm , +13 mm >6.5 m : -6 mm , +19 mm

Grade	% Chemical Composition (Max)							Mechanical Properties (Min)				
	C	Si	Mn	P	S	Al	CE	Yield Strength	Tensile Strength	Elongation Circular Hollow Sections (d _s /t)		
								MPa	MPa	≤ 15	> 15 ≤ 30	> 30
C250, C250L0	0.12	0.05	0.50	0.03	0.03	0.10	0.25	250	320	18	20	22
C350, C350L0	0.20	0.45	1.60	0.03	0.03	0.10	0.43	350	430	16	18	20
C450, C450L0	0.20	0.45	1.70	0.03	0.03	0.10	0.43	450	500	12	14	16

C 250									C 350								
Nominal Size		Outside Diameter (d _s)	Thickness (t)	Mass Per Unit Length	Cross Sectional Area	Geometrical Moment of Inertia	Modulus of Section	Radius of Gyration	Nominal Size		Outside Diameter (d _s)	Thickness (t)	Mass Per Unit Length	Cross Sectional Area	Geometrical Moment of Inertia	Modulus of Section	Radius of Gyration
mm	inch	mm	mm	kg/m	mm ²	10 ⁶ mm ⁴	10 ³ mm ³	mm	mm	inch	mm	mm	kg/m	mm ²	10 ⁶ mm ⁴	10 ³ mm ³	mm
15	1/2"	21.3	2.60	1.20	153	0.00681	0.639	6.68	15	1/2"	21.3	2.00	0.952	121	0.00571	0.536	6.86
			3.20	1.43	182	0.00768	0.722	6.50			26.9	2.00	1.23	156	0.0122	0.907	8.83
20	3/4"	26.9	2.60	1.56	198	0.0148	1.10	8.64	20	1"	33.7	2.00	1.56	199	0.0251	1.49	11.2
			3.20	1.87	238	0.0170	1.27	8.46				2.60	1.99	254	0.0309	1.84	11.0
25	1"	33.7	3.20	2.41	307	0.0360	2.14	10.8	32	1 1/4"	42.4	2.00	1.99	254	0.0519	2.45	14.3
			4.00	2.93	373	0.0419	2.49	10.6				2.60	2.55	325	0.0646	3.05	14.1
32	1 1/4"	42.4	3.20	3.09	394	0.0762	3.59	13.9	40	1 1/2"	48.3	2.30	2.61	332	0.0881	3.65	16.3
			4.00	3.79	483	0.0899	4.24	13.6				2.90	3.25	414	0.107	4.43	16.1
40	1 1/2"	48.3	3.20	3.56	453	0.116	4.80	16.0	50	2"	60.3	2.30	3.29	419	0.177	5.85	20.5
			4.00	4.37	557	0.138	5.70	15.7				2.90	4.11	523	0.216	7.16	20.3
			5.40	5.71	728	0.170	7.04	15.3				2.30	4.19	533	0.363	9.55	26.1
50	2"	60.3	3.60	5.03	641	0.259	8.58	20.1	65	2 1/2"	76.1	3.20	5.75	733	0.488	12.8	25.8
			4.50	6.19	789	0.309	10.2	19.8				3.20	5.75	733	0.488	12.8	25.8
			5.40	7.31	931	0.354	11.8	19.5				2.60	5.53	705	0.657	14.8	30.5
65	2 1/2"	76.1	3.60	6.44	820	0.540	14.21	25.7	80	3"	88.9	3.20	6.76	862	0.792	17.8	30.3
			4.50	7.95	1010	0.651	17.1	25.4				4.80	9.96	1270	1.12	25.3	29.8
			5.90	10.20	1300	0.807	21.2	24.9				5.50	11.30	1440	1.26	28.3	29.6
80	3"	88.9	4.00	8.38	1070	0.963	21.7	30.0	90	3 1/2"	101.6	2.60	6.35	809	0.991	19.5	35.0
			5.00	10.30	1320	1.16	26.2	29.7				3.20	7.77	989	1.20	23.6	34.8
			5.90	12.10	1540	1.33	30.0	29.4				3.20	7.77	989	1.20	23.6	34.8
90	3 1/2"	101.6	4.00	9.63	1230	1.46	28.8	34.2	100	4"	114.3	3.20	8.77	1120	1.72	30.2	39.3
			5.00	11.90	1520	1.77	34.9	34.5				3.60	9.83	1250	1.92	33.6	39.2
			5.40	14.50	1850	2.75	48.0	38.5				4.80	13.00	1650	2.48	43.4	38.8
100	4"	114.3	4.50	12.20	1550	2.34	41.0	38.9	125	5"	139.7	3.00	10.10	1290	3.01	43.1	48.3
			5.40	17.90	2280	5.14	73.7	47.5				3.50	11.80	1500	3.47	49.7	48.2
			5.90	21.30	2710	8.65	105	56.5				6.00	16.00	2040	3.00	52.5	38.3
125	5"	139.7	5.00	16.60	2120	4.81	68.8	47.7	150	6"	165.1	3.00	12.00	1530	5.02	60.8	57.3
			5.40	17.90	2280	5.14	73.7	47.5				3.50	13.90	1780	5.80	70.3	57.1
			5.90	21.30	2710	8.65	105	56.5				4.80	19.40	2470	8.25	98.0	57.8
150	6"	165.1	5.00	19.70	2510	8.07	97.7	56.6	200	8"	219.1	4.80	25.40	3230	18.6	169	75.8
			5.40	21.30	2710	8.65	105	56.5				6.40	33.60	4280	24.2	221	75.2
			5.90	21.30	2710	8.65	105	56.5				8.20	42.60	5430	30.3	276	74.6
200	8"	219.1	5.00	19.70	2510	8.07	97.7	56.6	250	10"	273.1	6.40	42.10	5360	47.7	349	94.3
			5.40	21.30	2710	8.65	105	56.5				9.30	60.50	7710	67.1	492	93.3
			5.90	21.30	2710	8.65	105	56.5				6.40	50.10	6380	80.5	497	112
300	12"	323.9	5.00	19.70	2510	8.07	97.7	56.6	350	14"	355.6	6.40	55.10	7020	107	602	123
			5.40	21.30	2710	8.65	105	56.5				9.50	73.70	9380	116	717	111
			5.90	21.30	2710	8.65	105	56.5				6.40	63.10	8040	161	792	141
400	16"	406.4	5.00	19.70	2510	8.07	97.7	56.6	400	16"	406.4	6.40	63.10	8040	161	792	141
			5.40	21.30	2710	8.65	105	56.5				9.50	93.00	11800	233	1150	140

Dimension Tolerances

Outside Diameter	±1% with a minimum of ±0.5 mm and maximum of ±10 mm
Thickness	±10%
Weight	-4% , +Not Limit

Square Hollow Section for Structural Purposes

AS 1163

Grade	% Chemical Composition (Max)							Mechanical Properties (Min)				
	C	Si	Mn	P	S	Al	CE	Yield Strength	Tensile Strength	Elongation Rectangular Hollow Sections (b/t,d/t)		
								MPa	MPa	≤ 15	> 15 ≤ 30	> 30
C250, C250L0	0.12	0.05	0.50	0.03	0.03	0.10	0.25	250	320	18	20	22
C350, C350L0	0.20	0.45	1.60	0.03	0.03	0.10	0.43	350	430	16	18	20
C450, C450L0	0.20	0.45	1.70	0.03	0.03	0.10	0.43	450	500	12	14	16

Nominal Size d x b		Thickness (t)	Mass Per Unit length	Cross Sectional Area	Geometrical Moment of Inertia I _x , I _y	Modulus of Section Z _x , Z _y	Radius of Gyration i _x , i _y
mm	inch						
20 x 20	3/4" x 3/4"	1.6	0.873	111	0.00608	0.608	7.39
25 x 25	1" x 1"	1.6	1.12	143	0.0128	1.02	9.44
		2.0	1.36	174	0.0148	1.19	9.24
		2.5	1.64	209	0.0169	1.35	8.99
		3.0	1.89	241	0.0184	1.47	8.74
30 x 30	1 1/8" x 1 1/8"	1.6	1.38	175	0.0231	1.54	11.5
		2.0	1.68	214	0.0272	1.81	11.3
35 x 35	1 3/8" x 1 3/8"	1.6	1.63	207	0.0379	2.16	13.5
		2.0	1.99	254	0.0451	2.58	13.3
		2.5	2.42	309	0.0529	3.02	13.1
		3.0	2.83	361	0.0595	3.40	12.8
40 x 40	1 1/2" x 1 1/2"	1.6	1.88	239	0.0579	2.90	15.6
		2.0	2.31	294	0.0694	3.47	15.4
		2.5	2.82	359	0.0822	4.11	15.1
		4.0	4.09	521	0.105	5.26	14.2
50 x 50	2" x 2"	1.6	2.38	303	0.117	4.68	19.6
		2.0	2.93	374	0.141	5.66	19.5
		2.5	3.60	459	0.169	6.78	19.2
		3.0	4.25	541	0.195	7.79	19.0
		4.0	5.35	681	0.229	9.15	18.3
65 x 65	2 1/2" x 2 1/2"	2.0	3.88	494	0.323	9.94	25.6
		2.5	4.78	609	0.391	12.0	25.3
		3.0	5.66	721	0.454	14.0	25.1
75 x 75	3" x 3"	2.5	5.56	709	0.614	16.4	29.4
		3.0	6.60	841	0.716	19.1	29.2
		3.5	7.53	959	0.797	21.3	28.8
		4.0	8.49	1080	0.882	23.5	28.6
		5.0	10.3	1310	1.03	27.5	28.0
		6.0	12.0	1530	1.16	30.9	27.5
89 x 89	3 1/2" x 3 1/2"	3.5	9.06	1150	1.37	30.9	34.5
		5.0	12.5	1590	1.81	40.7	33.7
		6.0	14.6	1870	2.06	46.2	33.2
100 x 100	4" x 4"	3.0	8.96	1140	1.77	35.4	39.4
		4.0	11.6	1480	2.23	44.6	38.8
		5.0	14.2	1810	2.66	53.1	38.3
		6.0	16.7	2130	3.04	60.7	37.7
		9.0	23.5	3000	3.91	78.1	36.1
125 x 125	5" x 5"	4.0	14.8	1880	4.52	72.3	49.0
		5.0	18.2	2310	5.44	87.1	48.5
		6.0	21.4	2730	6.29	101	48.0
		9.0	30.6	3900	8.38	134	46.4
150 x 150	6" x 6"	5.0	22.1	2810	9.70	129	58.7
		6.0	26.2	3330	11.3	150	58.2
		9.0	37.7	4800	15.4	205	56.6
200 x 200	8" x 8"	5.0	29.9	3810	23.9	239	79.1
		6.0	35.6	4530	28.0	280	78.6
		9.0	51.8	6600	39.2	392	77.1
250 x 250	10" x 10"	6.0	45.0	5730	56.2	450	99.0
		9.0	65.9	8400	79.8	639	97.5

Dimension Tolerances	Length of Side	Thickness	Weight
	±1% with minimum of ±0.5 mm	±10%	-4% , +Not Limit

AS 1163

Rectangular Hollow Section for Structural Purposes

Grade	% Chemical Composition (Max)							Mechanical Properties (Min)				
	C	Si	Mn	P	S	Al	CE	Yield Strength	Tensile Strength	Elongation Rectangular Hollow Sections (b/t,d/t)		
								MPa	MPa	≤ 15	> 15 ≤ 30	> 30
C250, C250L0	0.12	0.05	0.50	0.03	0.03	0.10	0.25	250	320	18	20	22
C350, C350L0	0.20	0.45	1.60	0.03	0.03	0.10	0.43	350	430	16	18	20
C450, C450L0	0.20	0.45	1.70	0.03	0.03	0.10	0.43	450	500	12	14	16

Nominal Size d x b		Thickness (t)	Mass Per Unit length	Cross Sectional Area	Geometrical Moment of Inertia		Modulus of Section		Radius of Gyration	
					I _x 10 ⁶ mm ⁴	I _y 10 ⁶ mm ⁴	Z _x 10 ³ mm ³	Z _y 10 ³ mm ³	i _x mm	i _y mm
mm	inch	mm	kg/m	mm ²	10 ⁶ mm ⁴	10 ⁶ mm ⁴	10 ³ mm ³	10 ³ mm ³	mm	mm
50 x 20	2" x 3/4"	1.6	1.63	207	0.0608	0.0142	2.43	1.42	17.1	8.29
		2.0	1.99	254	0.0723	0.0167	2.89	1.67	16.9	8.11
		2.5	2.42	309	0.0848	0.0192	3.39	1.92	16.6	7.89
		3.0	2.83	361	0.0951	0.0212	3.81	2.12	16.2	7.67
50 x 25	2" x 1"	1.6	1.75	223	0.0702	0.0237	2.81	1.90	17.7	10.3
		2.0	2.15	274	0.0838	0.0281	3.35	2.25	17.5	10.1
		2.5	2.62	334	0.0989	0.0328	3.95	2.62	17.2	9.91
		3.0	3.07	391	0.1120	0.0367	4.47	2.93	16.9	9.69
65 x 35	2 1/2" x 1 3/8"	2.0	2.93	374	0.204	0.0778	6.28	4.44	23.4	14.4
		2.5	3.60	459	0.244	0.0926	7.52	5.29	23.1	14.2
		3.0	4.25	541	0.281	0.106	8.65	6.04	22.8	14.0
75 x 25	3" x 1"	1.6	2.38	303	0.197	0.0347	5.26	2.78	25.5	10.7
		2.0	2.93	374	0.238	0.0414	6.36	3.31	25.3	10.5
		2.5	3.60	459	0.285	0.0487	7.60	3.89	24.9	10.3
75 x 50	3" x 2"	2.0	3.72	474	0.372	0.199	9.91	7.96	28.0	20.5
		2.5	4.58	584	0.450	0.240	12.0	9.60	27.7	20.3
		3.0	5.42	691	0.522	0.278	13.9	11.1	27.5	20.0
		4.0	6.92	881	0.630	0.335	16.8	13.4	26.7	19.5
100 x 50	4" x 2"	2.0	4.50	574	0.750	0.257	15.0	10.3	36.2	21.2
		2.5	5.56	709	0.912	0.311	18.2	12.4	35.9	20.9
		3.0	6.60	841	1.06	0.361	21.3	14.4	35.6	20.7
		3.5	7.53	959	1.18	0.400	23.6	16.0	35.1	20.4
		4.0	8.49	1080	1.31	0.441	26.1	17.6	34.8	20.2
		5.0	10.3	1310	1.53	0.511	30.6	20.4	34.1	19.7
125 x 75	5" x 3"	3.0	8.96	1140	2.43	1.11	38.9	29.5	46.1	31.1
		4.0	11.6	1480	3.05	1.39	48.9	37.0	45.4	30.6
		5.0	14.2	1810	3.64	1.65	58.3	43.9	44.8	30.1
		6.0	18.2	2310	4.44	2.01	70.6	53.6	43.7	29.6
150 x 50	6" x 2"	3.0	8.96	1140	2.99	0.526	39.8	21.1	51.2	21.5
		4.0	11.6	1480	3.74	0.653	49.8	26.1	50.2	21.0
		5.0	14.2	1810	4.44	0.765	59.2	30.6	49.5	20.5
150 x 100	6" x 4"	4.0	14.8	1880	5.87	3.15	78.2	63	55.9	40.9
		5.0	18.2	2310	7.07	3.79	94.3	75.7	55.3	40.4
		6.0	21.4	2730	8.17	4.36	109	87.3	54.7	40.0
200 x 100	8" x 4"	4.0	17.9	2280	11.9	4.07	119	81.5	72.1	42.3
		5.0	22.1	2810	14.4	4.92	144	98.3	71.5	41.8
		6.0	26.2	3330	16.7	5.69	167	114	70.8	41.3
		9.0	37.7	4800	22.8	7.64	228	153	68.9	39.9
250 x 150	8" x 6"	5.0	29.9	3810	32.7	15.0	262	199	92.6	62.6
		6.0	35.6	4530	38.4	17.5	307	233	92.0	62.2
		9.0	51.8	6600	53.7	24.3	430	324	90.2	60.7

Dimension Tolerances	Length of Side	Thickness	Weight
	±1% with minimum of ±0.5 mm	±10%	-4% , +Not Limit

Carbon Steel Tubes for Scaffolding

BS 1139

% Chemical Composition (Max)						Mechanical Properties (Min)			
C	Si	Mn	P	S	N	Yield Strength		Tensile Strength	Elongation (on L ₀ = 5.65 √S ₀)
						MPa		MPa	%
0.20	0.30	-	0.05	0.05	0.009	235		340 - 480	24

Outside Diameter	Inside Diameter	Wall Thickness	Weight
mm	mm	mm	kg/m
48.30	40.30	4.00	4.37

Dimension Tolerances	Diameter		Thickness	Weight
	OD 48.3 mm	: ±0.5 mm	-10% , +Not Limit	Single Tube : -8.0% , +12.0%
ID 40.3 mm	: -2.6 mm	Batches of Tube : ±7.5%		

Cold Formed Welded Structural Hollow Section

BS EN 10219

Grade	% Chemical Composition (Max)					Mechanical Properties (Min)					Minimum Average Absorbed Energy for Standard Test Pieces Joule
	C	Si	Mn	P	S	Yield Strength MPa	Tensile Strength		Elongation %	Impact Test	
							t < 3 mm MPa	3 mm ≤ t ≤ 40 mm MPa		Test Temperature °C	
S235JRH	0.17	-	1.40	0.040	0.040	235	360 - 510	360 - 510	24	20	27
S275J0H	0.20	-	1.50	0.035	0.035	275	430 - 580	410 - 560	20	0	27
S275J2H	0.20	-	1.50	0.030	0.030	275	430 - 580	410 - 560	20	-20	27
S355J0H	0.22	0.55	1.60	0.035	0.035	355	510 - 680	470 - 630	20	0	27
S355J2H	0.22	0.55	1.60	0.030	0.030	355	510 - 680	470 - 630	20	-20	27

Dimension Tolerances	Outside Diameter	Thickness	Weight
	±1% with a minimum of ± 0.5 mm and a maximum of ±10 mm	for D ≤ 406.4 mm t ≤ 5 mm : ±10% t > 5 mm : ±0.5 mm for D > 406.4 mm ±10% with a maximum of 2 mm	±6%

Nominal Size	Outside Diameter	Thickness (t)	Mass Per Unit Length	Cross Sectional Area	Second Moment of Area	Elastic Section Modulus	Radius of Gyration	Nominal Size	Outside Diameter	Thickness (t)	Mass Per Unit Length	Cross Sectional Area	Second Moment of Area	Elastic Section Modulus	Radius of Gyration				
inch	mm	mm	kg/m	cm ²	cm ⁴	cm ³	cm	inch	mm	mm	kg/m	cm ²	cm ⁴	cm ³	cm				
1/2"	21.3	2.00	0.95	1.21	0.571	0.536	0.686	5"	139.7	6.00	19.8	25.2	564	80.8	4.73				
		2.50	1.16	1.48	0.664	0.623	0.671			6.30	20.7	26.4	589	84.3	4.72				
		3.00	1.35	1.72	0.741	0.696	0.656			8.00	26.0	33.1	720	103	4.66				
						10.00	32.0			40.7	862	123	4.60						
3/4"	26.9	2.00	1.23	1.56	1.22	0.907	0.883		6"	168.3	3.00	12.2	15.6	532	63.3	5.85			
		2.50	1.50	1.92	1.44	1.07	0.867				4.00	16.2	20.6	697	82.8	5.81			
		3.00	1.77	2.25	1.63	1.21	0.852				5.00	20.1	25.7	856	102	5.78			
						6.00	24.0				30.6	1009	120	5.74					
1"	33.7	2.00	1.56	1.99	2.51	1.49	1.12			7"	193.7	6.30	25.2	32.1	1053	125	5.73		
		2.50	1.92	2.45	3.00	1.78	1.11					8.00	31.6	40.3	1297	154	5.67		
		3.00	2.27	2.89	3.44	2.04	1.09	10.00				39.0	49.7	1564	186	5.61			
						4.00	18.7	23.8				1073	111	6.71					
1 1/4"	42.4	2.00	1.99	2.54	5.19	2.45	1.43	8"			219.1	5.00	23.3	29.6	1320	136	6.67		
		2.50	2.46	3.13	6.26	2.95	1.41					6.00	27.8	35.4	1560	161	6.64		
		3.00	2.91	3.71	7.25	3.42	1.40		6.30			29.1	37.1	1830	168	6.63			
		4.00	3.79	4.83	8.99	4.24	1.36		8.00			36.6	46.7	2016	208	6.57			
1 1/2"	48.3	2.00	2.28	2.91	7.81	3.23	1.64		10"		273.0	10.00	45.3	57.7	2442	252	6.50		
		2.50	2.82	3.60	9.46	3.92	1.62					12.00	53.8	68.5	2839	293	6.44		
		3.00	3.35	4.27	11.0	4.55	1.61			12.50		55.9	71.2	2934	303	6.42			
		4.00	4.37	5.57	13.8	5.70	1.57			4.00		21.2	27.0	1564	143	7.61			
		2"	60.3	2.50	3.56	4.54	19.0			6.30	2.05	12"	323.9	5.00	39.3	50.1	6369	393	11.3
3.00	4.24			5.40	22.2	7.37	2.03			6.00	47.0			59.9	7572	468	11.2		
4.00	5.55			7.07	28.2	9.34	2.00	6.30		49.3	62.9			7929	490	11.2			
5.00	6.82			8.69	33.5	11.1	1.96	8.00		62.3	79.4			9910	612	11.2			
2 1/2"	76.1			2.00	3.65	4.66	32.0	8.40		2.62	14"		355.6	10.00	92.3	118	14320	884	11.0
		2.50	4.54	5.78	39.2	10.3	2.60	12.00		96.0				122	14850	917	11.0		
		3.00	5.41	6.89	46.1	12.1	2.59	5.00	43.2	55.1				8464	476	12.4			
		4.00	7.11	9.06	59.1	15.5	2.55	6.00	51.7	65.9				10070	566	12.4			
		3"	88.9	5.00	8.77	11.2	70.9	18.6	2.52	16"			406.4	6.30	54.3	69.1	10550	593	12.4
				6.00	10.4	13.2	81.8	21.5	2.49					8.00	68.6	87.4	13200	742	12.3
6.30	10.8			13.8	84.8	22.3	2.48	10.00	85.2			109		16220	912	12.2			
2.00	4.29			5.46	51.6	11.6	3.07	12.00	102			130		19140	1076	12.2			
3 1/2"	101.6			2.50	5.33	6.79	63.4	14.3	3.06			5"	139.7	3.00	10.1	12.9	301	43.1	4.83
				3.00	6.36	8.10	74.8	16.8	3.04					4.00	13.4	17.1	393	56.2	4.80
		4.00	8.38	10.7	96.3	21.7	3.00	5.00	16.6		21.2			481	68.8	4.77			
		5.00	10.3	13.2	116	26.2	2.97	6.00	16.0		20.4			300	52.5	3.83			
		4"	114.3	6.00	12.3	15.6	135	30.4	2.94										
				6.30	12.8	16.3	140	31.5	2.93										
2.00	4.91			6.26	77.6	15.3	3.52												
2.50	6.11			7.78	95.6	18.8	3.50												
3.00	7.29			9.29	113	22.3	3.49												
4.00	9.63			12.3	146	28.8	3.45												

Cold Formed Welded Structural Hollow Section

BS EN 10219

Grade	% Chemical Composition (Max)					Mechanical Properties (Min)					Minimum Average Absorbed Energy for Standard Test Pieces
	C	Si	Mn	P	S	Yield Strength	Tensile Strength		Elongation	Impact Test	
							t < 3 mm	3 mm ≤ t ≤ 40 mm			°C
	MPa	MPa	MPa	%	Joule						
S235JRH	0.17	-	1.40	0.040	0.040	235	360 - 510	360 - 510	24	20	27
S275J0H	0.20	-	1.50	0.035	0.035	275	430 - 580	410 - 560	20	0	27
S275J2H	0.20	-	1.50	0.030	0.030	275	430 - 580	410 - 560	20	-20	27
S355J0H	0.22	0.55	1.60	0.035	0.035	355	510 - 680	470 - 630	20	0	27
S355J2H	0.22	0.55	1.60	0.030	0.030	355	510 - 680	470 - 630	20	-20	27

Nominal Size	Thickness	Mass Per Unit Length	Cross Sectional Area	Geometrical Moment of Inertia I _x , I _y	Modulus of Section Z _x , Z _y	Radius of Gyration i _x , i _y	Nominal Size	Thickness	Mass Per Unit Length	Cross Sectional Area	Geometrical Moment of Inertia I _x , I _y	Modulus of Section Z _x , Z _y	Radius of Gyration i _x , i _y
H x B	(t)	kg/m	cm ²	cm ⁴	cm ³	cm	H x B	(t)	kg/m	cm ²	cm ⁴	cm ³	cm
mm	mm	kg/m	cm ²	cm ⁴	cm ³	cm	mm	mm	kg/m	cm ²	cm ⁴	cm ³	cm
20 x 20	2.0	1.05	1.34	0.692	0.692	0.720	100 x 100	6.0	17.0	21.6	311	62.3	3.79
25 x 25	2.0	1.36	1.74	1.48	1.19	0.924		6.3	17.5	22.2	314	62.8	3.76
	2.5	1.64	2.09	1.69	1.35	0.899		8.0	21.4	27.2	366	73.2	3.67
	3.0	1.89	2.41	1.84	1.47	0.874		10.0	25.6	32.6	411	82.2	3.55
30 x 30	2.0	1.68	2.14	2.72	1.81	1.13	120 x 120	3.0	10.8	13.8	312	52.1	4.76
	2.5	2.03	2.59	3.16	2.10	1.10		4.0	14.2	18.1	402	67.0	4.71
	3.0	2.36	3.01	3.50	2.34	1.08		5.0	17.5	22.4	485	80.9	4.66
40 x 40	2.0	2.31	2.94	6.94	3.47	1.54		6.0	20.7	26.4	562	93.7	4.61
	2.5	2.82	3.59	8.22	4.11	1.51	6.3	21.4	27.3	572	95.3	4.58	
	3.0	3.30	4.21	9.32	4.66	1.49	8.0	26.4	33.6	677	113	4.49	
	4.0	4.20	5.35	11.1	5.54	1.44	10.0	31.8	40.6	777	129	4.38	
50 x 50	2.0	2.93	3.74	14.1	5.66	1.95	150 x 150	4.0	18.0	22.9	808	108	5.93
	2.5	3.60	4.59	16.9	6.78	1.92		5.0	22.3	28.4	982	131	5.89
	3.0	4.25	5.41	19.5	7.79	1.90		6.0	26.4	33.6	1146	153	5.84
	4.0	5.45	6.95	23.7	9.49	1.85		6.3	27.4	34.8	1174	156	5.80
	5.0	6.56	8.36	27.0	10.8	1.80		8.0	33.9	43.2	1412	188	5.71
60 x 60	2.0	3.56	4.54	25.1	8.38	2.35	200 x 200	10.0	41.3	52.6	1653	220	5.61
	2.5	4.39	5.59	30.3	10.1	2.33		4.0	24.3	30.9	1968	197	7.97
	3.0	5.19	6.61	35.1	11.7	2.31		5.0	30.1	38.4	2410	241	7.93
	4.0	6.71	8.55	43.6	14.5	2.26		6.0	35.8	45.6	2833	283	7.88
	5.0	8.13	10.4	50.5	16.8	2.21		6.3	37.2	47.4	2922	292	7.85
	6.0	9.45	12.0	56.1	18.7	2.16		8.0	46.5	59.2	3566	357	7.76
	6.3	9.55	12.2	54.4	18.1	2.11		10.0	57.0	72.6	4251	425	7.65
80 x 80	3.0	7.07	9.01	87.8	22.0	3.12	250 x 250	12.0	66.0	84.1	4730	473	7.50
	4.0	9.22	11.7	111	27.8	3.07		12.5	68.3	87.0	4859	486	7.47
	5.0	11.3	14.4	131	32.9	3.03		5.0	38.0	48.4	4805	384	9.97
	6.0	13.2	16.8	149	37.3	2.98		6.0	45.2	57.6	5672	454	9.92
	6.3	13.5	17.2	149	37.1	2.94		6.3	47.1	60.0	5873	470	9.89
	8.0	16.4	20.8	168	42.1	2.84		8.0	59.1	75.2	7229	578	9.80
90 x 90	3.0	8.01	10.2	127	28.3	3.53	300 x 300	10.0	72.7	92.6	8707	697	9.70
	4.0	10.5	13.3	162	36.0	3.48		12.0	84.8	108	9859	789	9.55
	5.0	12.8	16.4	193	42.9	3.43		12.5	88.0	112	10160	813	9.52
	6.0	15.1	19.2	220	49.0	3.39		6.0	54.7	69.6	9964	664	12.0
	6.3	15.5	19.7	221	49.1	3.35		6.3	57.0	72.6	10340	689	11.9
	8.0	18.9	24.0	255	56.6	3.25		8.0	71.6	91.2	12800	853	11.8
100 x 100	3.0	8.96	11.4	177	35.4	3.94	10.0	88.4	113	15520	1035	11.7	
	4.0	11.7	14.9	226	45.3	3.89	12.0	104	132	17770	1184	11.6	
	5.0	14.4	18.4	271	54.2	3.84	12.5	108	137	18350	1223	11.6	

Dimension Tolerances	Length of Side	Thickness	Weight
	H,B < 100 mm 100 mm ≤ H, B ≤ 200 mm H,B > 200 mm	: ±1% with a minimum of ±0.5 mm : ±0.8% : ±0.6%	t ≤ 5 mm ±10% t > 5 mm ±0.5 mm

Grade	% Chemical Composition (Max)					Mechanical Properties (Min)					Minimum Average Absorbed Energy for Standard Test Pieces
	C	Si	Mn	P	S	Yield Strength	Tensile Strength		Elongation	Impact Test	
							t < 3 mm	3 mm ≤ t ≤ 40 mm			
	MPa	MPa	MPa	%	°C	Joule					
S235JRH	0.17	-	1.40	0.040	0.040	235	360 - 510	360 - 510	24	20	27
S275J0H	0.20	-	1.50	0.035	0.035	275	430 - 580	410 - 560	20	0	27
S275J2H	0.20	-	1.50	0.030	0.030	275	430 - 580	410 - 560	20	-20	27
S355J0H	0.22	0.55	1.60	0.035	0.035	355	510 - 680	470 - 630	20	0	27
S355J2H	0.22	0.55	1.60	0.030	0.030	355	510 - 680	470 - 630	20	-20	27

Nominal Size	Thick-ness	Mass Per Unit Length	Cross Sectional Area	Geometrical Moment of Inertia		Modulus of Section		Radius of Gyration		Nominal Size	Thick-ness	Mass Per Unit Length	Cross Sectional Area	Geometrical Moment of Inertia		Modulus of Section		Radius of Gyration		
				I _x	I _y	Z _x	Z _y	i _x	i _y					I _x	I _y	Z _x	Z _y	i _x	i _y	
H x B	(t)	kg/m	cm ²	cm ⁴	cm ⁴	cm ³	cm ³	cm	cm	H x B	(t)	kg/m	cm ²	cm ⁴	cm ⁴	cm ³	cm ³	cm	cm	
mm	mm	kg/m	cm ²	cm ⁴	cm ⁴	cm ³	cm ³	cm	cm	mm	mm	kg/m	cm ²	cm ⁴	cm ⁴	cm ³	cm ³	cm	cm	
40 x 20	2.0	1.68	2.14	4.05	1.34	2.02	1.34	1.38	0.793	200 x 100	5.0	22.3	28.4	1459	497	146	99.4	7.17	4.19	
60 x 40	2.0	2.93	3.74	18.4	9.83	6.14	4.92	2.22	1.62	200 x 100	6.0	26.4	33.6	1703	577	170	115	7.12	4.14	
	2.5	3.60	4.59	22.1	11.7	7.36	5.87	2.19	1.60		6.3	27.4	34.8	1739	591	174	118	7.06	4.12	
	3.0	4.25	5.41	25.4	13.4	8.46	6.72	2.17	1.58		8.0	33.9	43.2	2091	705	209	141	6.95	4.04	
100 x 50	2.5	5.56	7.09	91.2	31.1	18.2	12.4	3.59	2.09	200 x 100	10.0	41.3	52.6	2444	818	244	164	6.82	3.94	
	3.0	6.60	8.41	106	36.1	21.3	14.4	3.56	2.07		250 x 150	5.0	30.1	38.4	3304	1508	264	201	9.28	6.27
	4.0	8.59	10.9	134	44.9	26.8	18.0	3.50	2.03			6.0	35.8	45.6	3886	1768	311	236	9.23	6.23
	5.0	10.5	13.4	158	52.5	31.6	21.0	3.44	1.98			6.3	37.2	47.4	4001	1825	320	243	9.18	6.20
	6.0	12.3	15.6	179	58.7	35.8	23.5	3.38	1.94			8.0	46.5	59.2	4886	2219	391	296	9.08	6.12
6.3	12.5	15.9	176	58.2	35.1	23.3	3.32	1.91	10.0	57.0		72.6	5825	2634	466	351	8.96	6.02		
120 x 80	3.0	8.96	11.4	230	123	38.4	30.9	4.49	3.29	250 x 150	12.0	66.0	84.1	6458	2925	517	390	8.77	5.90	
	4.0	11.7	14.9	295	157	49.1	39.3	4.44	3.24		12.5	68.3	87.0	6633	3002	531	400	8.73	5.87	
	5.0	14.4	18.4	353	188	58.9	46.9	4.39	3.20		300 x 150	6.0	40.5	51.6	6074	2080	405	277	10.8	6.35
	6.0	17.0	21.6	406	215	67.7	53.8	4.33	3.15			6.3	42.2	53.7	6266	2150	418	287	10.8	6.32
6.3	17.5	22.2	408	217	68.1	54.3	4.28	3.12	8.0	52.8		67.2	7684	2623	512	350	10.7	6.25		
8.0	21.4	27.2	476	252	79.3	62.9	4.18	3.04	10.0	64.8		82.6	9209	3125	614	417	10.6	6.15		
140 x 80	4.0	13.0	16.5	430	180	61.4	45.1	5.10	3.30	300 x 200	12.0	75.4	96.1	13000	3498	687	466	10.4	6.03	
	5.0	16.0	20.4	517	216	73.9	54.0	5.04	3.26		12.5	78.1	99.5	10590	3595	706	479	10.3	6.01	
	6.0	18.9	24.0	597	248	85.3	62.0	4.98	3.21		6.0	45.2	57.6	7370	3962	491	396	11.3	8.29	
	6.3	19.4	24.8	603	251	86.1	62.9	4.93	3.19		6.3	47.1	60.0	7624	4104	508	410	11.3	8.27	
150 x 100	8.0	23.9	30.4	708	293	101	73.3	4.82	3.10	8.0	59.1	75.2	9389	5042	626	504	11.2	8.19		
	4.0	14.9	18.9	595	319	79.3	63.7	5.60	4.10	350 x 250	10.0	72.7	92.6	11310	6058	754	606	11.1	8.09	
	5.0	18.3	23.4	719	384	95.9	76.8	5.55	4.05		12.0	84.8	108	12790	6854	853	685	10.9	7.96	
	6.0	21.7	27.6	835	444	111	88.8	5.50	4.01		12.5	88.0	112	13180	7060	879	706	10.8	7.94	
	6.3	22.4	28.5	848	453	113	90.5	5.45	3.98		6.0	54.7	69.6	12460	7458	712	597	13.4	10.3	
8.0	27.7	35.2	1008	536	134	107	5.35	3.90	6.3		57.0	72.6	12920	7744	738	620	13.3	10.3		
160 x 80	10.0	33.4	42.6	1162	614	155	123	5.22	3.80	8.0	71.6	91.2	16000	9573	914	766	13.2	10.2		
	4.0	14.2	18.1	598	204	74.7	50.9	5.74	3.36	400 x 200	10.0	88.4	113	19410	11590	1109	927	13.1	10.1	
	5.0	17.5	22.4	722	244	90.2	61.0	5.68	3.30		12.0	104	132	22200	13260	1268	1061	13.0	10.0	
	6.0	20.7	26.4	836	281	105	70.2	5.62	3.26		12.5	108	137	22920	13690	1310	1095	12.9	9.99	
6.3	21.4	27.3	846	286	106	71.4	5.57	3.24	8.0		71.6	91.2	18970	6517	949	652	14.4	8.45		
200 x 100	4.0	18.0	22.9	1200	411	120	82.2	7.23	4.23	12.5	108	137	27100	9260	1355	926	14.1	8.22		

Dimension Tolerances	Length of Side		Thickness		Weight	
	H, B < 100 mm	: ±1% with a minimum of ±0.5 mm	t ≤ 5 mm	±10%	±6%	
100 mm ≤ H, B ≤ 200 mm	: ±0.8%	t > 5 mm	±0.5 mm			
H, B > 200 mm	: ±0.6%					



Carbon Steel Tubes for General Structure

JIS G3444

Grade	% Chemical Composition (Max)					Mechanical Properties (Min)		
	C	Si	Mn	P	S	Yield Strength	Tensile Strength	Elongation
						MPa	MPa	%
STK400	0.25	-	-	0.040	0.040	235	400	23
STK490	0.18	0.55	1.65	0.035	0.035	315	490	23

Nominal Size	Outside Diameter	Thickness (t)	Weight	Cross Sectional Area	Geometrical Moment of Inertia	Modulus of Section	Radius of Gyration	Nominal Size	Outside Diameter	Thickness (t)	Weight (plain end)	Cross Sectional Area	Geometrical Moment of Inertia	Modulus of Section	Radius of Gyration	
mm	mm	mm	kg/m	cm ²	cm ⁴	cm ³	cm	mm	mm	mm	kg/m	cm ²	cm ⁴	cm ³	cm	
15	21.7	2.00	0.972	1.238	0.607	0.560	0.700	175	190.7	4.50	20.7	26.32	1140	120	6.59	
20	27.2	2.00	1.24	1.583	1.26	0.930	0.890			5.30	24.2	30.87	1330	139	6.56	
		2.30	1.41	1.799	1.41	1.03	0.880	6.00		27.3	34.82	1490	156	6.53		
25	34.0	2.30	1.80	2.291	2.89	1.70	1.12	200		216.3	7.00	31.7	40.40	1710	179	6.50
32	42.7	2.30	2.29	2.919	5.97	2.80	1.43				8.20	36.9	47.01	1960	206	6.46
		2.50	2.48	3.157	6.40	3.00	1.42	4.50			23.5	29.94	1680	155	7.49	
40	48.6	2.30	2.63	3.345	8.99	3.70	1.64	250	267.4		5.80	30.1	38.36	2130	197	7.45
		2.50	2.84	3.621	9.65	3.97	1.63				6.00	31.1	39.64	2190	203	7.44
2.80		3.16	4.029	10.6	4.36	1.62	7.00	36.1			46.03	2520	233	7.40		
3.20		3.58	4.564	11.8	4.86	1.61	8.00	41.1		52.35	2840	263	7.37			
50	60.5	2.30	3.30	4.205	17.8	5.90	2.06	300		318.5	8.20	42.1	53.61	2910	269	7.36
		3.20	4.52	5.760	23.7	7.84	2.03				6.00	38.7	49.27	4210	315	9.24
4.00		5.57	7.100	28.5	9.41	2.00	6.60	42.4	54.08		4600	344	9.22			
65	76.3	2.80	5.08	6.465	43.7	11.5	2.60	350	355.6		7.00	45.0	57.26	4860	363	9.21
		3.20	5.77	7.349	49.2	12.9	2.59				8.00	51.2	65.19	5490	411	9.18
4.00		7.13	9.085	59.5	15.6	2.58	9.00	57.3			73.06	6110	457	9.14		
80	89.1	2.80	5.96	7.591	70.7	15.9	3.05	400		406.4	9.30	59.2	75.41	6290	470	9.13
		3.20	6.78	8.636	79.8	17.9	3.04				6.00	46.2	58.91	7190	452	11.1
90	101.6	3.20	7.76	9.892	120	23.6	3.48	350			355.6	6.90	53.0	67.55	8200	515
		4.00	9.63	12.26	146	28.8	3.45		8.00			61.3	78.04	9410	591	11.0
5.00		11.9	15.17	177	34.9	3.42	9.00	68.7	87.51			10500	659	10.9		
100	114.3	3.20	8.77	11.17	172	30.2	3.93	350	355.6			10.30	78.3	99.73	11900	744
		3.50	9.56	12.18	187	32.7	3.92			6.40		55.1	70.21	10700	602	12.3
4.50		12.2	15.52	234	41.0	3.89	7.90	67.7		86.29		13000	734	12.3		
125	139.8	3.60	12.1	15.40	357	51.1	4.82	350		355.6	9.00	76.9	98.00	14700	828	12.3
		4.00	13.4	17.07	394	56.3	4.80				9.50	81.1	103.3	15500	871	12.2
4.50		15.0	19.13	438	62.7	4.79	12.00	102			129.5	19100	1080	12.2		
6.00		19.8	25.22	566	80.9	4.74	12.70	107	136.8		20100	1130	12.1			
150	165.2	4.50	17.8	22.72	734	88.9	5.68	400	406.4		7.90	77.6	98.90	19600	967	14.1
		5.00	19.8	25.16	808	97.8	5.67				9.00	88.2	112.4	22200	1090	14.1
		6.00	23.6	30.01	952	115	5.63	9.50		93.0	118.5	23300	1150	14.0		
7.10		27.7	35.26	1100	134	5.60	12.00	117		148.7	28900	1420	14.0			
											12.70	123	157.1	30500	1500	13.9

Dimension Tolerances	Outside Diameter		Thickness	
	Class 1	: OD < 50 mm : OD ≥ 50 mm	: ±0.5 mm : ±1%	Class 1
Class 2	: OD < 50 mm : OD ≥ 50 mm	: ±0.25 mm : ± 0.5%	Class 2	t < 3.0 mm : ±0.3 mm 3.0 mm ≤ t < 12.0 mm : ±10% t ≥ 12.0 mm : -1.2 mm, +10%



Grade	% Chemical Composition (Max)					Mechanical Properties (Min)		
	C	Si	Mn	P	S	Yield Strength	Tensile Strength	Elongation
						MPa	MPa	%
STKR400	0.25	-	-	0.040	0.040	245	400	23
STKR490	0.18	0.55	1.50	0.040	0.040	325	490	23

Nominal Size A x B	Thickness (t)	Weight	Cross Sectional Area A	Geometrical Moment of Inertia I _x , I _y	Modulus of Section Z _x , Z _y	Radius of Gyration i _x , i _y
mm	mm	kg/m	cm ²	cm ⁴	cm ³	cm
40 x 40	1.6	1.88	2.392	5.79	2.90	1.56
	2.3	2.62	3.332	7.73	3.86	1.52
50 x 50	1.6	2.38	3.032	11.7	4.68	1.96
	2.3	3.34	4.252	15.9	6.34	1.93
	3.2	4.50	5.727	20.4	8.16	1.89
60 x 60	1.6	2.88	3.672	20.7	6.89	2.37
	2.3	4.06	5.172	28.3	9.44	2.34
	3.2	5.50	7.007	36.9	12.3	2.30
75 x 75	1.6	3.64	4.632	41.3	11.0	2.99
	2.3	5.14	6.552	57.1	15.2	2.95
	3.2	7.01	8.927	75.5	20.1	2.91
	4.5	9.55	12.17	98.6	26.3	2.85
80 x 80	2.3	5.50	7.012	69.9	17.5	3.16
	3.2	7.51	9.567	92.7	23.2	3.11
	4.5	10.3	13.07	122	30.4	3.05
90 x 90	2.3	6.23	7.932	101	22.4	3.56
	3.2	8.51	10.85	135	29.9	3.52
100 x 100	2.3	6.95	8.852	140	27.9	3.97
	3.2	9.52	12.13	187	37.5	3.93
	4.0	11.7	14.95	226	45.3	3.89
	4.5	13.1	16.67	249	49.9	3.87
	6.0	17.0	21.63	311	62.3	3.79
	9.0	24.1	30.67	408	81.6	3.65
125 x 125	3.2	12.0	15.33	376	60.1	4.95
	4.5	16.6	21.17	506	80.9	4.89
	5.0	18.3	23.36	553	88.4	4.86
	6.0	21.7	27.63	641	103	4.82
	9.0	31.1	39.67	865	138	4.67
150 x 150	4.5	20.1	25.67	896	120	5.91
	5.0	22.3	28.36	982	131	5.89
	6.0	26.4	33.63	1150	153	5.84
	9.0	38.2	48.67	1580	210	5.69
175 x 175	4.5	23.7	30.17	1450	166	6.93
	5.0	26.2	33.36	1590	182	6.91
	6.0	31.1	39.63	1860	213	6.86
200 x 200	4.5	27.2	34.67	2190	219	7.95
	6.0	35.8	45.63	2830	283	7.88
	8.0	46.9	59.79	3620	362	7.78
	9.0	52.3	66.67	3990	399	7.73
	12.0	67.9	86.53	4980	498	7.59
250 x 250	5.0	38.0	48.36	4810	384	9.97
	6.0	45.2	57.63	5670	454	9.92
	8.0	59.5	75.79	7320	585	9.82
	9.0	66.5	84.67	8090	647	9.78
	12.0	86.8	110.5	10300	820	9.63
300 x 300	4.5	41.3	52.67	7630	508	12.0
	6.0	54.7	69.63	9960	664	12.0
	9.0	80.6	102.7	14300	956	11.8
	12.0	106	134.5	18300	1220	11.7

Dimension Tolerances	Length of Side	Thickness
	A, B ≤ 100 mm : ±1.5 mm A, B > 100 mm : ±1.5%	t < 3.0 mm : ±0.3 mm t ≥ 3.0 mm : ±10%



Carbon Steel Rectangular Tubes for General Structure

JIS G3466

Grade	% Chemical Composition (Max)					Mechanical Properties (Min)		
	C	Si	Mn	P	S	Yield Strength	Tensile Strength	Elongation
						MPa	MPa	%
STKR400	0.25	-	-	0.040	0.040	245	400	23
STKR490	0.18	0.55	1.50	0.040	0.040	325	490	23

Nominal Size A x B	Thickness (t)	Weight kg/m	Cross Sectional Area A cm ²	Geometrical Moment of Inertia		Modulus of Section		Radius of Gyration	
				I _x cm ⁴	I _y cm ⁴	Z _x cm ³	Z _y cm ³	i _x cm	i _y cm
mm	mm	kg/m	cm ²	cm ⁴	cm ⁴	cm ³	cm ³	cm	cm
60 x 30	1.60	2.13	2.712	12.5	4.25	4.16	2.83	2.15	1.25
	2.30	2.98	3.792	16.8	5.65	5.61	3.76	2.11	1.22
	3.20	3.99	5.087	21.4	7.08	7.15	4.72	2.05	1.18
75 x 45	1.60	2.88	3.672	28.4	12.9	7.56	5.75	2.78	1.88
	2.30	4.06	5.172	38.9	17.6	10.4	7.82	2.74	1.84
	3.20	5.50	7.007	50.8	22.8	13.5	10.1	2.69	1.80
100 x 50	1.60	3.64	4.632	61.3	21.1	12.3	8.43	3.64	2.13
	2.30	5.14	6.552	84.8	29.0	17.0	11.6	3.60	2.10
	3.20	7.01	8.927	112	38.0	22.5	15.2	3.55	2.06
	4.50	9.55	12.17	147	48.9	29.3	19.5	3.47	2.00
125 x 75	2.30	6.95	8.852	192	87.5	30.6	23.3	4.65	3.14
	3.20	9.52	12.13	257	117	41.1	31.1	4.60	3.10
	4.00	11.7	14.95	311	141	49.7	37.5	4.56	3.07
	4.50	13.1	16.67	342	155	54.8	41.2	4.53	3.04
	6.00	17.0	21.63	428	192	68.5	51.1	4.45	2.98
150 x 75	3.20	10.8	13.73	402	137	53.6	36.6	5.41	3.16
150 x 80	4.50	15.2	19.37	563	211	75.0	52.9	5.39	3.30
	5.00	16.8	21.36	614	230	81.9	57.5	5.36	3.28
	6.00	19.8	25.23	710	264	94.7	66.1	5.31	3.24
150 x 100	3.20	12.0	15.33	488	262	65.1	52.5	5.64	4.14
	4.50	16.6	21.17	658	352	87.7	70.4	5.58	4.08
	6.00	21.7	27.63	835	444	111	88.8	5.50	4.01
	9.00	31.1	39.67	1130	595	151	119	5.33	3.87
200 x 100	4.50	20.1	25.67	1330	455	133	90.9	7.20	4.21
	6.00	26.4	33.63	1700	577	170	115	7.12	4.14
	9.00	38.2	48.67	2350	782	235	156	6.94	4.01
200 x 150	4.50	23.7	30.17	1760	1130	176	151	7.64	6.13
	6.00	31.1	39.63	2270	1460	227	194	7.56	6.06
	9.00	45.3	57.67	3170	2020	317	270	7.41	5.93
250 x 150	6.00	35.8	45.63	3890	1770	311	236	9.23	6.23
	9.00	52.3	66.67	5480	2470	438	330	9.06	6.09
	12.00	67.9	86.53	6850	3070	548	409	8.90	5.95
300 x 200	6.00	45.2	57.63	7370	3960	491	396	11.3	8.29
	9.00	66.5	84.67	10500	5630	702	563	11.2	8.16
	12.00	86.8	110.5	13400	7110	890	711	11.0	8.02
350 x 150	6.00	45.2	57.63	8910	2390	509	319	12.4	6.44
	9.00	66.5	84.67	12700	3370	726	449	12.3	6.31
	12.00	86.8	110.5	16100	4210	921	562	12.1	6.17
400 x 200	6.00	54.7	69.63	14800	5090	739	509	14.6	8.55
	9.00	80.6	102.7	21300	7270	1070	727	14.4	8.42
	12.00	106	134.5	27300	9230	1360	923	14.2	8.23

Dimension Tolerances	Length of Side	Thickness
	A, B ≤ 100 mm : ±1.5 mm A, B > 100 mm : ±1.5%	t < 3.0 mm : ±0.3 mm t ≥ 3.0 mm : ±10%



TIS 107

Hollow Structural Steel Sections : Round Tubes



Grade	% Chemical Composition (Max)					Mechanical Properties (Min)			Marking Color
	C	Si	Mn	P	S	Yield Strength	Tensile Strength	Elongation	
						MPa	MPa	%	
HS 41	0.28	-	-	0.048	0.048	235	402	23	Green
HS 50	0.21	0.57	1.53	0.048	0.048	314	490	23	Red
HS 51	0.33	0.37	0.33 - 1.03	0.048	0.048	353	500	15	White

Nominal Size		Outside Diameter	Thickness (t)	Weight	Cross Sectional Area	Geometrical Moment of Inertia	Modulus of Section	Radius of Gyration
mm	inch	mm	mm	kg/m	cm ²	cm ⁴	cm ³	cm
15	1/2"	21.7	2.00	0.972	1.238	0.607	0.560	0.700
20	3/4"	27.2	2.30	1.41	1.799	1.41	1.03	0.880
25	1"	34.0	2.30	1.80	2.291	2.89	1.70	1.12
32	1 1/4"	42.7	2.30	2.29	2.919	5.97	2.80	1.43
40	1 1/2"	48.6	2.30	2.63	3.345	8.99	3.70	1.64
			3.20	3.58	4.564	11.8	4.86	1.61
50	2"	60.5	3.20	4.52	5.760	23.7	7.84	2.03
			4.00	5.57	7.100	28.5	9.41	2.00
65	2 1/2"	76.3	3.20	5.77	7.349	49.2	12.9	2.59
			4.00	7.13	9.085	59.5	15.6	2.56
80	3"	89.1	3.20	6.78	8.636	79.8	17.9	3.04
			4.00	8.39	10.69	97.0	21.8	3.01
90	3 1/2"	101.6	3.20	7.76	9.892	120	23.6	3.48
			4.00	9.63	12.26	146	28.8	3.45
100	4"	114.3	3.20	8.77	11.17	172	30.2	3.93
			4.50	12.2	15.52	234	41.0	3.89
			5.60	15.00	19.12	283	49.6	3.85
125	5"	139.8	4.50	15.0	19.13	438	62.7	4.79
			6.00	19.8	25.22	566	80.9	4.74
150	6"	165.2	4.50	17.8	22.72	734	88.9	5.68
			6.00	23.6	30.01	952	115	5.63
175	7"	190.7	5.00	22.9	29.17	1260	132	6.57
			7.00	31.7	40.40	1710	179	6.50
200	8"	216.3	6.00	31.1	39.61	2190	203	7.44
			8.00	41.1	52.35	2840	263	7.37

Dimension Tolerances	Outside Diameter	Thickness	Weight
	DN ≤ 50 mm : ±0.5 mm DN > 50 mm : ±1%	2.0 mm ≤ t ≤ 3.2 mm : ±0.3 mm 4.0 mm ≤ t ≤ 8.0 mm : ±10%	±10%



Hollow Structural Steel Sections : Square Tubes

TIS 107

Grade	% Chemical Composition (Max)					Mechanical Properties (Min)			Marking Color
	C	Si	Mn	P	S	Yield Strength	Tensile Strength	Elongation	
						MPa	MPa	%	
HS 41	0.28	-	-	0.048	0.048	235	402	23	Green
HS 50	0.21	0.57	1.53	0.048	0.048	314	490	23	Red

Nominal Size A x B	Thickness (t)	Weight	Cross Sectional Area	Geometrical Moment of Inertia I _x , I _y	Modulus of Section Z _x , Z _y	Radius of Gyration i _x , i _y
mm	mm	kg/m	cm ²	cm ⁴	cm ³	cm
25 x 25	2.0	1.36	1.737	1.48	1.19	0.924
	2.3	1.53	1.972	1.61	1.29	0.904
32 x 32	2.3	2.04	2.596	3.71	2.32	1.20
	3.2	2.69	3.423	4.54	2.84	1.15
38 x 38	2.3	2.47	3.148	6.54	3.44	1.44
	3.2	3.29	4.191	8.18	4.30	1.40
50 x 50	2.3	3.34	4.252	15.9	6.34	1.93
	3.2	4.50	5.727	20.4	8.16	1.89
60 x 60	2.3	4.06	5.172	28.3	9.44	2.34
	3.2	5.50	7.007	36.9	12.3	2.30
	4.0	6.71	8.548	43.6	14.5	2.26
75 x 75	3.2	7.01	8.927	75.5	20.1	2.91
	4.0	8.59	10.95	90.2	24.1	2.87
90 x 90	3.2	8.51	10.85	135	29.9	3.52
	4.0	10.5	13.35	162	36.0	3.48
	4.5	11.7	14.87	178	39.5	3.46
100 x 100	3.2	9.52	12.13	187	37.5	3.93
	4.0	11.7	14.95	226	45.3	3.89
	4.5	13.1	16.67	249	49.9	3.87
150 x 150	4.5	20.1	25.67	896	120	5.91
	6.0	26.4	33.63	1150	153	5.84
175 x 175	4.5	23.7	30.17	1450	166	6.93
	6.0	31.1	39.63	1860	213	6.86
200 x 200	6.0	35.8	45.63	2830	283	7.88
	8.0	46.9	59.79	3620	362	7.78
	9.0	52.3	66.67	3990	399	7.73
250 x 250	6.0	45.2	57.63	5670	454	9.92
	8.0	59.2	75.79	7320	585	9.82
	9.0	66.5	84.67	8090	647	9.78
300 x 300	6.0	54.7	69.63	9960	664	12.0
	9.0	80.6	102.7	14300	956	11.8
	12.0	106	134.5	18300	1220	11.7

Dimension Tolerances	Length of Side	Thickness	Weight
	A,B ≤ 100 mm : ±1.5 mm A,B > 100 mm : ±1.5%	2.0 mm ≤ t ≤ 3.2 mm : ±0.3 mm 4.0 mm ≤ t ≤ 12.0 mm : ±10%	±10%



Grade	% Chemical Composition (Max)					Mechanical Properties (Min)			Marking Color
	C	Si	Mn	P	S	Yield Strength	Tensile Strength	Elongation	
						MPa	MPa	%	
HS 41	0.28	-	-	0.048	0.048	235	402	23	Green
HS 50	0.21	0.57	1.53	0.048	0.048	314	490	23	Red

Nominal Size A x B mm	Thickness (t) mm	Weight kg/m	Cross Sectional Area cm ²	Geometrical Moment of Inertia		Modulus of Section		Radius of Gyration	
				I _x cm ⁴	I _y cm ⁴	Z _x cm ³	Z _y cm ³	i _x cm	i _y cm
50 x 25	2.3	2.44	3.102	9.31	3.10	3.72	2.48	1.73	1.00
	3.2	3.24	4.127	11.6	3.80	4.65	3.04	1.68	0.96
60 x 30	2.3	2.98	3.792	16.8	5.65	5.61	3.76	2.11	1.22
	3.2	3.99	5.087	21.4	7.08	7.15	4.72	2.05	1.18
75 x 38	2.3	3.81	4.850	34.6	12.0	9.23	6.30	2.67	1.57
	3.2	5.15	6.559	45.0	15.4	12.0	8.09	2.62	1.53
75 x 45	2.3	4.06	5.172	38.9	17.6	10.4	7.82	2.74	1.84
	3.2	5.50	7.007	50.8	22.8	13.5	10.1	2.69	1.80
100 x 50	3.2	7.01	8.927	112	38.0	22.5	15.2	3.55	2.06
	4.0	8.59	10.95	142	46.7	28.4	18.7	3.55	2.03
	4.5	9.55	12.17	147	48.9	29.3	19.5	3.47	2.00
125 x 75	3.2	9.52	12.13	257	117	41.1	31.1	4.60	3.10
	4.0	11.7	14.95	311	141	49.7	37.5	4.56	3.07
	4.5	13.1	16.67	342	155	54.8	41.2	4.53	3.04
150 x 80	4.5	15.2	19.37	563	211	75.0	52.9	5.39	3.30
	6.0	19.8	25.23	710	264	94.7	66.1	5.31	3.24
200 x 100	4.5	20.1	25.67	1330	455	133	90.9	7.20	4.21
	6.0	26.4	33.63	1700	577	170	115	7.12	4.14

Dimension Tolerances	Length of Side	Thickness	Weight
	A, B ≤ 100 mm : ±1.5 mm A, B > 100 mm : ±1.5%	2.0 mm ≤ t ≤ 3.2 mm : ±0.3 mm 4.0 mm ≤ t ≤ 12.0 mm : ±10%	±10%



Cold Formed Structural Steel Sections : Lip Channel Steel



TIS 1228

Grade	% Chemical Composition (Max)			Mechanical Properties (Min)		
	C	P	S	Yield Strength	Tensile Strength	Elongation
				MPa	MPa	%
SSC 400	0.28	0.06	0.060	245	400 - 540	t ≤ 5 mm = 21 t > 5 mm = 17

Specified Item and Dimension			Dimensional Tolerances
Length of Side	A		±1.5 mm
	H	< 150 mm	±1.5 mm
		150 mm ≤ H < 300 mm	±2.0 mm
		≥ 300 mm	±3.0 mm
C		±2.0 mm	
Thickness	1.60 mm		±0.22 mm
	2.00 mm and 2.30 mm		±0.25 mm
	2.80 mm		±0.28 mm
	3.20 mm		±0.30 mm
	4.00 mm and 4.50 mm		±0.45 mm
	6.00 mm		±0.60 mm
Length	≤ 7 m		-0 mm , +40 mm
	> 7 m		+ 40 mm , then +5 mm for each 1 m length that over 7 m
Angle Between Adjacent Plate Portions			±1.5°
Culvature			≤ 0.2% of the overall length
Weight Per Meter			±10%

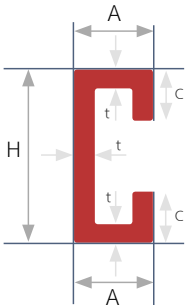

Lip Channel Steel

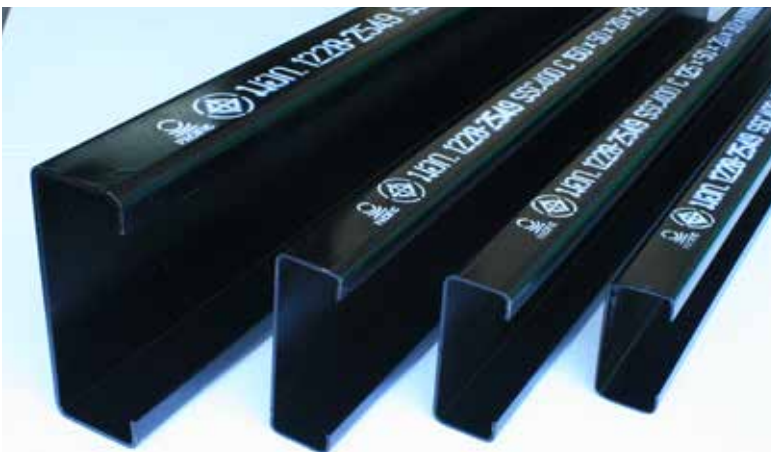



TIS 1228

Cold Formed Structural Steel Sections : Lip Channel Steel



Nominal Size	Thickness	Weight	Cross Sectional Area	Center of Gravity		Geometrical Moment of Inertia		Modulus of Section		Radius of Gyration		Center of Shear	
				cm		cm ⁴		cm ³		cm		cm	
				Cx	Cy	Ix	Iy	Zx	Zy	ix	iy	Sx	Sy
60 x 30 x 10	1.6	1.63	2.072	0	1.06	11.60	2.56	3.88	1.32	2.37	1.11	2.50	0
	2.0	1.99	2.537	0	1.06	14.00	3.01	4.65	1.55	2.35	1.09	2.50	0
	2.3	2.25	2.872	0	1.06	15.60	3.32	5.20	1.71	2.33	1.07	2.50	0
70 x 40 x 25	1.6	2.38	3.032	0	1.80	22.00	8.00	6.29	3.64	2.69	1.62	4.40	0
75 x 35 x 15	2.3	2.89	3.677	0	1.29	31.00	6.58	8.28	2.98	2.91	1.34	3.10	0
75 x 45 x 15	1.6	2.32	2.952	0	1.72	27.10	8.71	7.24	3.13	3.03	1.72	4.10	0
	2.0	2.86	3.637	0	1.72	33.00	10.50	8.79	3.76	3.01	1.70	4.00	0
	2.3	3.25	4.137	0	1.72	37.10	11.80	9.90	4.24	3.00	1.69	4.00	0
90 x 45 x 20	1.6	2.63	3.352	0	1.73	42.60	10.50	9.46	5.80	3.56	1.77	4.20	0
	2.3	3.70	4.712	0	1.73	58.60	14.20	13.00	5.14	3.53	1.74	4.10	0
	3.2	5.00	6.367	0	1.72	76.90	18.30	17.10	6.57	3.48	1.69	4.10	0
100 x 50 x 20	1.6	2.88	3.672	0	1.87	58.40	14.00	11.70	4.47	3.99	1.95	4.50	0
	2.0	3.56	4.537	0	1.86	71.40	16.90	14.30	5.40	3.97	1.93	4.40	0
	2.3	4.06	5.172	0	1.86	80.70	19.00	16.10	6.06	3.95	1.92	4.40	0
	2.8	4.87	6.205	0	1.88	99.80	23.20	20.00	7.44	3.96	1.91	4.30	0
	3.2	5.50	7.007	0	1.86	107.00	24.50	21.30	7.81	3.90	1.87	4.40	0
	4.0	6.71	8.548	0	1.86	127.00	28.70	25.40	9.13	3.85	1.83	4.30	0
	4.5	7.43	9.469	0	1.86	139.00	30.90	27.70	9.82	3.82	1.81	4.30	0
120 x 40 x 20	3.2	5.50	7.007	0	1.32	144.00	15.30	24.00	5.71	4.53	1.48	3.40	0
120 x 60 x 20	2.3	4.78	6.092	0	2.13	140.00	31.30	23.30	8.10	4.79	2.27	5.10	0
	3.2	6.51	8.287	0	2.12	186.00	40.90	31.00	10.50	4.74	2.22	4.90	0
120 x 60 x 25	4.5	9.20	11.720	0	2.25	252.00	58.00	41.90	15.50	4.63	2.22	5.30	0
125 x 50 x 20	2.3	4.51	5.747	0	1.69	137.00	20.60	21.90	6.22	4.88	1.89	4.10	0
	3.2	6.13	7.807	0	1.68	181.00	26.60	29.00	8.02	4.82	1.85	4.00	0
	4.0	7.50	9.548	0	1.68	217.00	33.10	34.70	9.38	4.77	1.81	4.00	0
	4.5	8.32	10.590	0	1.68	238.00	33.50	38.00	10.00	4.74	1.78	4.00	0
150 x 50 x 20	2.3	4.96	6.322	0	1.55	210.00	21.90	28.00	6.33	5.77	1.86	3.80	0
	3.2	6.76	8.607	0	1.54	280.00	28.30	37.40	8.19	5.71	1.81	3.80	0
	4.5	9.20	11.720	0	1.54	368.00	35.70	49.00	10.50	5.60	1.75	3.70	0
150 x 65 x 20	2.3	5.50	7.012	0	2.12	248.00	41.10	33.00	9.37	5.94	2.42	5.20	0
	3.2	7.51	9.567	0	2.11	332.00	53.80	44.30	12.20	5.89	2.37	5.10	0
	4.0	9.22	11.750	0	2.11	401.00	63.70	53.50	14.50	5.84	2.33	5.00	0
150 x 75 x 20	3.2	8.01	10.210	0	2.51	366.00	76.40	48.90	15.30	5.99	2.74	5.10	0
	4.0	9.85	12.550	0	2.51	445.00	91.00	59.30	18.20	5.95	2.69	5.80	0
	4.5	11.00	13.970	0	2.50	489.00	99.20	65.20	19.80	5.92	2.66	6.00	0
150 x 75 x 25	3.2	8.27	10.530	0	2.66	375.00	83.60	50.00	17.30	5.97	2.82	6.40	0
	4.0	10.20	12.950	0	2.65	455.00	99.80	60.60	20.60	5.93	2.78	6.30	0
	4.5	11.30	14.420	0	2.65	501.00	109.00	66.90	22.50	5.90	2.75	6.30	0
200 x 75 x 20	3.2	9.27	11.810	0	2.19	716.00	84.10	71.60	15.80	7.79	2.67	5.40	0
	4.0	11.40	14.550	0	2.19	871.00	100.00	87.10	18.90	7.74	2.62	5.30	0
	4.5	12.70	16.220	0	2.19	963.00	109.00	96.30	20.60	7.71	2.60	5.30	0
200 x 75 x 25	3.2	9.52	12.130	0	2.33	736.00	92.30	73.60	17.80	7.70	2.76	5.70	0
	4.0	11.70	14.950	0	2.32	895.00	110.00	89.50	21.30	7.74	2.72	5.70	0
	4.5	13.10	16.670	0	2.32	990.00	121.00	99.00	23.30	7.61	2.69	5.60	0
250 x 75 x 25	4.5	14.90	18.920	0	2.07	1690.00	129.00	135.00	23.80	9.44	2.62	5.10	0

Carbon Steel Pipes for Ordinary Piping

Grade	% Chemical Composition (Max)					Mechanical Properties (Min)			Marking Color
	C	Si	Mn	P	S	Yield Strength	Tensile Strength	Elongation	
						MPa	MPa	%	
SGP	-	-	-	0.04	0.04	-	290	19 - 25 up to wall thickness	White

Nominal Size		Outside Diameter		Thickness	Weight (plain end)
		mm			
mm	inch	STD	Tolerances	mm	kg/m
200	8"	216.3	±1.00	4.0	20.9
250	10"	267.4	±1.30	4.5	29.2
300	12"	318.5	±1.50	4.5	29.2
300	12"	318.5	±1.50	6.0	46.2

Dimension Tolerances	Thickness	Hydrostatic Test Pressure
		-12.5 % , +Not Limit

Carbon Steel Tubes for General Structure

Grade	% Chemical Composition (Max)					Mechanical Properties (Min)		
	C	Si	Mn	P	S	Yield Strength	Tensile Strength	Elongation
						MPa	MPa	%
STK400	0.25	-	-	0.040	0.040	235	400	23
STK490	0.18	0.55	1.65	0.035	0.035	315	490	23

Nominal Size	Outside Diameter	Thickness (t)	Weight	Cross Sectional Area	Geometrical Moment of Inertia	Modulus of Section	Radius of Gyration
mm	mm	mm	kg/m	cm ²	cm ⁴	cm ³	cm
65	76.3	2.3	4.20	5.347	36.6	9.60	2.62
250	267.4	4.5	29.2	37.16	3212	240	9.30

Dimension Tolerances	Outside Diameter		Thickness		
	Class 1	: OD < 50 mm : OD ≥ 50 mm	: ±0.5 mm : ±1%	Class 1	t < 4.0 mm : -0.5 mm , +0.6 mm 4.0 mm ≤ t < 12.0 mm : -12.5% , +15%
	Class 2	: OD < 50 mm : OD ≥ 50 mm	: ±0.25 mm : ± 0.5%	Class 2	t > 12.0 mm : -1.5 mm , +15% t < 3.0 mm : ±0.3 mm 3.0 mm ≤ t < 12.0 mm : ±10% t ≥ 12.0 mm : -1.2 mm , +10%

Carbon Steel Square Tubes for General Structure

Grade	% Chemical Composition (Max)					Mechanical Properties (Min)		
	C	Si	Mn	P	S	Yield Strength	Tensile Strength	Elongation
						MPa	MPa	%
STKR400	0.25	-	-	0.040	0.040	245	400	23
STKR490	0.18	0.55	1.50	0.040	0.040	325	490	23

Nominal Size A x B	Thickness (t)	Weight	Cross Sectional Area A	Geometrical Moment of Inertia I _x , I _y	Modulus of Section Z _x , Z _y	Radius of Gyration i _x , i _y
mm	mm	kg/m	cm ²	cm ⁴	cm ³	cm
50 x 50	6.0	7.56	9.633	30.1	12.0	1.77
75 x 75	6.0	12.3	15.63	121	32.2	2.78
150 x 150	3.2	14.5	18.53	660	88.0	5.97
250 x 250	4.5	34.3	43.67	4356	348	9.99

Dimension Tolerances	Length of Side	Thickness
	A, B ≤ 100 mm : ±1.5 mm A, B > 100 mm : ±1.5%	t < 3.0 mm : ±0.3 mm t ≥ 3.0 mm : ±10%

Carbon Steel Rectangular Tubes for General Structure

Grade	% Chemical Composition (Max)					Mechanical Properties (Min)		
	C	Si	Mn	P	S	Yield Strength	Tensile Strength	Elongation
						MPa	MPa	%
STKR400	0.25	-	-	0.040	0.040	245	400	23
STKR490	0.18	0.55	1.50	0.040	0.040	325	490	23

Nominal Size A x B	Thickness (t)	Weight	Cross Sectional Area A	Geometrical Moment of Inertia		Modulus of Section		Radius of Gyration	
				I _x	I _y	Z _x	Z _y	i _x	i _y
mm	mm	kg/m	cm ²	cm ⁴	cm ⁴	cm ³	cm ³	cm	cm
75 x 50	3.2	5.75	7.327	54.9	29.2	14.6	11.7	2.74	2.00
100 x 50	6.0	12.3	15.63	179	59.3	35.9	23.7	3.39	1.95
150 x 75	4.5	14.9	18.92	538	183	71.8	48.7	5.33	3.11
150 x 75	6.0	19.3	24.63	679	228	90.5	60.9	5.25	3.04
125 x 50	2.3	6.05	7.702	148	35.5	23.7	14.2	4.38	2.15
125 x 50	3.2	8.26	10.53	197	46.8	31.6	18.7	4.33	2.11
125 x 50	4.0	10.2	12.95	237	55.7	37.9	22.3	4.28	2.07
150 x 50	2.3	6.95	8.852	235	42.0	31.4	16.8	5.16	2.18
150 x 50	3.2	9.52	12.13	315	55.6	42.0	22.2	5.10	2.14
150 x 50	4.0	11.7	14.95	381	66.3	50.8	26.5	5.05	2.11
150 x 50	4.5	13.1	16.67	419	72.5	55.9	29.0	5.01	2.09
150 x 50	5.0	14.4	18.36	456	78.2	60.7	31.3	4.98	2.06
150 x 50	6.0	17.0	21.63	523	88.6	69.7	35.4	4.92	2.02
200 x 50	3.2	12.0	15.33	669	73.1	66.9	29.2	6.61	2.18
200 x 50	6.0	21.7	27.63	1136	118	114	47.1	6.41	2.06
200 x 100	3.2	14.5	18.53	979	337	97.9	67.4	7.27	4.27

Dimension Tolerances	Length of Side	Thickness
	A, B ≤ 100 mm : ±1.5 mm A, B > 100 mm : ±1.5%	t < 3.0 mm : ±0.3 mm t ≥ 3.0 mm : ±10%

SUMMARY STANDARD SPECIFICATIONS



Specification	Scope	Grade	% Chemical Composition Percentage (Max)					Mechanical Properties (Min)		
			C	Si	Mn	P	S	Yield Strength	Tensile Strength	Elongation
								MPa	MPa	%
ASTM A53	E.R.W. Carbon Steel Pipes for Mechanical and Pressure Applications	Grade A	0.25	-	0.95	0.05	0.045	205	330	As Per Standard
		Grade B	0.30	-	1.20	0.05	0.045	240	415	As Per Standard
ASTM A795	E.R.W Carbon Steel Pipes for Fire Protection Use	Grade A	0.25	-	0.95	0.035	0.035	-	-	-
		Grade B	0.30	-	1.20	0.035	0.035	-	-	-
AS 1074	Steel Tubes and Tubulars for Ordinary Service	-	-	-	-	0.045	0.045	195	320-460	20
BS EN 10255 (Transition from BS1387)	Carbon Steel Tubes	S 195T No.1.0026	0.20	-	1.40	0.035	0.030	195	320-520	20
JIS G3452	Carbon Steel Pipes for Ordinary Piping	SGP	-	-	-	0.04	0.04	-	290	3 mm < t ≤ 4 mm : 19 4 mm < t ≤ 5 mm : 20 5 mm < t ≤ 6 mm : 22 6 mm < t ≤ 7 mm : 24 7 mm < t ≤ 8 mm : 25
JIS G3454	Carbon Steel Tubes for Pressure Service	STPG370	0.25	0.35	0.30 - 0.90	0.04	0.04	215	370	30
		STPG410	0.30	0.35	0.30 - 1.00	0.04	0.04	245	410	25
TIS 276 & TIS 277	Steel Pipes & Galvanized Steel Pipes	-	-	-	-	-	-	-	320	20
TIS 427	Electrically Welded Steel Water Pipe	-	0.250	-	-	0.040	0.050	165	310 - 380	27
		-	0.250	-	-	0.040	0.050	205	380 - 450	22
		-	0.300	-	-	0.040	0.050	230	≥415	20
TIS 770	Zinc Coated Steel Conduits for Electrical Wiring	-	-	-	-	-	-	-	-	-
		-	-	-	-	-	-	-	-	-
		-	-	-	-	-	-	-	-	-

Carbon Steel Pipes for ORDINARY PURPOSES & PIPING SYSTEM



SUMMARY STANDARD SPECIFICATIONS

Hydrostatic Test	Dimensional Tolerances			Specification
	MPa (Bar)	Diameter	Wall Thickness	
Sch 40 = 4.8 (48) - 17.2 (172)	NPS ≤ 1 ½ in (40 mm) : ±0.016 in (0.41 mm)	-12.5% , +Not Limit	±10%	ASTM A53
Sch 40 = 4.8 (48) - 17.2 (172)	NPS ≥ 2 in (50 mm) : ±1% from specified OD			
Sch 10 = 4.8 (48) - 8.3 (83)	NPS ≤ 1 ½ in (40 mm) : ±0.016 in (0.41 mm)	-12.5% , +Not Limit	±5%	ASTM A795
Sch 10 = 4.8 (48) - 8.3 (83)	NPS ≥ 2 in (50 mm) : ±1% from specified OD			
5.0 (50)	Per Standard Table (Page 17)	Light Class : -8% , +Not Limit M, H Class : -10% , +Not Limit	-8% , +10%	AS 1074
5.0 (50)		Type L1, L2 : -8% , + by mass tolerance M, H Series and Type L : ±10%	Type L1 , L2 : -8% , +10% M, H Series and Type L : ±7.5%	BS EN 10255 (Transition from BS1387)
2.5 (25)	DN ≤ 50 mm : ±0.50 mm DN = 65 mm : ±0.70 mm 80 mm < DN ≤ 150 mm : ±0.80 mm DN = 175 mm : ±0.90 mm DN = 200 mm : ±1.00 mm DN = 225 mm : ±1.20 mm DN = 250 mm : ±1.30 mm DN = 300 mm : ±1.50 mm	-12.5% , +Not Limit	-	JIS G3452
Sch 40 = 6.0 (60)	DN ≤ 25 mm : ±0.3 mm DN ≥ 32 mm : ±0.8% DN ≥ 350 mm : ±0.5%	t < 3.00 mm : ± 0.30 mm t ≥ 3.00 mm : ± 10%	-	JIS G3454
5.0 (50)	-	Type 1, 2 : -8% , +Not Limit Type 3, 4 : -12.5% , +Not Limit	Type 1,2,3 : -8% , +10% Type 4 : ±5%	TIS 276 & TIS 277
3.31 - 8.93 4.12 - 11.10 4.62 - 12.45	OD < 500 mm : ±1%	- 0.25 mm , + Not Limit	-	TIS 427
-	15 mm ≤ DN ≤ 50 mm : ±0.2 mm DN = 65 mm : ±0.3 mm DN = 80 mm : ±0.4 mm 90 mm ≤ DN ≤ 100 mm : ±0.5 mm	-	-	TIS 770
-	15 mm ≤ DN ≤ 50 mm : ±0.2 mm 65 mm ≤ DN ≤ 100 mm : ±0.3 mm	15 mm ≤ DN ≤ 25 mm : -0 mm , +0.4 mm 32 mm ≤ DN ≤ 100 mm : -0 mm , +0.5 mm	-	
-	15 mm ≤ DN ≤ 50 mm : ±0.4 mm 65 mm ≤ DN ≤ 100 mm : ±0.6 mm 125 mm ≤ DN ≤ 150 mm : ±1.5 mm	-12.5% , +0	-	

Carbon Steel Pipes for ORDINARY PURPOSES & PIPING SYSTEM

SUMMARY STANDARD SPECIFICATIONS



Specification	Scope	Grade	% Chemical Composition Percentage (Max)					Mechanical Properties (Min)		
			C	Si	Mn	P	S	Yield Strength	Tensile Strength	Elongation
								MPa	MPa	%
ASTM A500	E.R.W. Carbon Steel Round Pipe for General Structure	Grade A	0.30	-	1.40	0.045	0.045	230	310	25
		Grade B	0.30	-	1.40	0.045	0.045	290	400	23
		Grade C	0.27	-	1.40	0.045	0.045	315	425	21
		Grade D	0.30	-	1.40	0.045	0.045	250	400	23
	E.R.W. Carbon Steel Square & Rectangular Pipe for General Structure	Grade A	0.30	-	1.40	0.045	0.045	270	310	25
		Grade B	0.30	-	1.40	0.045	0.045	315	400	23
		Grade C	0.27	-	1.40	0.045	0.045	345	425	21
		Grade D	0.30	-	1.40	0.045	0.045	250	400	23
AS 1163	Structural Steel in Round Tube	C250, C250L0	0.12	0.05	0.50	0.03	0.03	250	320	18 - 22
		C350, C350L0	0.20	0.45	1.60	0.03	0.03	350	430	16 - 20
		C450, C450L0	0.20	0.45	1.70	0.03	0.03	450	500	12 - 16
	Structural Steel in Square and in Rectangle Tube	C250, C250L0	0.12	0.05	0.50	0.03	0.03	250	320	18 - 22
		C350, C350L0	0.20	0.45	1.60	0.03	0.03	350	430	16 - 20
		C450, C450L0	0.20	0.45	1.70	0.03	0.03	450	500	12 - 16
BS 1139 TYPE4	Metal Scaffolding	-	0.20	0.30	-	0.05	0.05	235	340 - 480	24
BS EN 10219	Cold Formed Welded Structural Hollow Section	S235JRH	0.17	-	1.40	0.040	0.040	235	360-510	24
		S275J0H	0.20	-	1.50	0.035	0.035	275	410-560	20
		S275J2H	0.20	-	1.50	0.030	0.030	275	410-560	20
		S355J0H	0.22	0.55	1.60	0.035	0.035	355	470-630	20
		S355J2H	0.22	0.55	1.60	0.030	0.030	355	470-630	20
JIS G3444	Carbon Steel Tubes for General Structure	STK290	-	-	-	0.050	0.050	-	290	30
		STK400	0.25	-	-	0.040	0.040	235	400	23
		STK490	0.18	0.55	1.65	0.035	0.035	315	490	23
		STK500	0.24	0.35	0.30 - 1.30	0.040	0.040	355	500	15
		STK540	0.23	0.55	1.50	0.040	0.040	390	540	20
		JIS G3466	Carbon Steel Square and Rectangular Tubes for General Structure	STKR400	0.25	-	-	0.040	0.040	245
STKR490	0.18			0.55	1.50	0.040	0.040	325	490	23
TIS 107	Hollow Structural Steel Sections : Round Tubes	HS 41	0.28	-	-	0.048	0.048	235	402	23
		HS 50	0.21	0.57	1.53	0.048	0.048	314	490	23
		HS 51	0.33	0.37	0.33 - 1.03	0.048	0.048	353	500	15
	Hollow Structural Steel Sections : Square and Rectangular Tubes	HS 41	0.28	-	-	0.048	0.048	235	402	23
HS 50		0.21	0.57	1.53	0.048	0.048	314	490	23	
TIS 1228	Cold Formed Structural Steel Sections : Lip Channel Steel	SSC 400	0.28	-	-	0.060	0.060	245	400 - 540	t ≤ 5 mm = 21 t > 5 mm = 17

Carbon Steel Pipes for GENERAL STRUCTURE PURPOSES



SUMMARY STANDARD SPECIFICATIONS

Dimensional Tolerances			Specification
Diameter	Wall Thickness	Weight	
NPS ≤ 1 ½ in : ±0.5% NPS ≥ 2 in : ±0.75%	±10 % of wall thickness	-	ASTM A500
DN ≤ 2 ½ in (65 mm) : ± 0.020 in (0.50 mm) 2 ½ in < DN ≤ 3 ½ in (65-90mm) : ± 0.025 in (0.60 mm) 3 ½ in < DN ≤ 5 ½ in (90-140 mm) : ± 0.030 in (0.80 mm) 5 ½ in (140 mm) < DN : 0.01 time large flat dimension			
±1% with a minimum of ±0.5 mm and a maximum of ±10 mm	±10%	-4% , +Not Limit	AS 1163
± 1% with a minimum of ± 0.5 mm	±10%	-4% , +Not Limit	
OD 48.3 mm : ±0.5 mm ID 40.3 mm : -2.6 mm	-10% , +Not Limit	Single -8% , +12.0% Batch ±7.5%	BS 1139 TYPE4
CHS ± 1% with a minimum of ±0.5 mm and a maximum of ± 10 mm SHS and RHS H, B < 100 mm : ±1% with a minimum of ±0.5mm 100 ≤ H, B ≤ 200 mm : ±0.8% H, B > 200 mm : ±0.6%	CHS for D ≤ 406.4 mm t ≤ 5 mm : ±10% t > 5 mm : ±0.5 mm for D > 406.4 mm ±10% with a maximum of 2 mm SHS and RHS t ≤ 5 mm : ±10% t > 5 mm : ±0.5 mm	±6%	BS EN 10219
Class 1 OD < 50 mm , ±0.5 mm OD ≥ 50 mm ±1% Class 2 OD < 50 mm : ±0.25 mm OD ≥ 50 mm : ±0.5%	Class 1 t < 4.0 mm : -0.5 mm , +0.6 mm 4.0 mm ≤ t < 12.0 mm : -12.5% , +15% t ≥ 12.0 mm : -1.5 mm , +15% Class 2 t < 3.0 mm : ±0.3 mm 3.0 mm ≤ t < 12.0 mm : ±10% t ≥ 12.0 mm : -1.2 mm , +10%	-	JIS G3444
A, B ≤ 100 mm : ±1.5 mm A, B > 100 mm : ±1.5%	t < 3.0 mm : ± 0.3 mm t ≥ 3.0 mm : ± 10%	-	JIS G3466
DN ≤ 50 mm : ±0.5mm DN > 50 mm : ±1%	2.0 mm ≤ t ≤ 3.2 mm : ± 0.3 mm 4.0 mm ≤ t ≤ 8.0 mm : ± 10%	±10%	TIS 107
A, B ≤ 100 mm : ±1.5mm A, B > 100 mm : ±1.5%	2.0 mm ≤ t ≤ 3.2 mm : ±0.3 mm 4.0 mm ≤ t ≤ 12.0 mm : ±10%		
Length of side A : ±1.5 mm H < 150 mm : ±1.5 mm 150 mm ≤ H < 300 mm : ±2.0 mm H ≥ 300 mm : ±3.0 mm C : ±2.0 mm	t = 1.60 mm : ±0.22 mm t = 2.00 & 2.30 mm : ±0.25 mm t = 2.80 mm : ±0.28 mm t = 3.20 mm : ±0.30 mm t = 4.00 & 4.5 mm : ±0.45 mm t = 6.00 mm : ±0.60 mm	±10%	TIS 1228

Carbon Steel Pipes for GENERAL STRUCTURE PURPOSES



Pacific Pipe Products

REFERENCE PROJECTS

Reference Projects

Pacific Pipe Products



Application	Project	Province
Airport	Air Traffic Control Tower, Don Muang Airport	Bangkok
	Airport Terminal and Office building, Chiangmai Airport	Chiangmai
	Airport, Phuket	Phuket
	Suvarnabhumi Airport	Samutprakarn
Government Office	Court of Justice, Dusit	Bangkok
	Thai Palaiment Building	Bangkok
	Police Apartment Project	Country
	Supreme Court	Bangkok
	Government Complex Center	Bangkok
	Maliwan Palace	Bangkok
	Bank of Thailand	Khonkaen
	The National Anti - Corruption Commission	Nonthaburi
Retail / Mixed Use	THE ONE UP Village	Bangkok
	BIG C	Maharakham
	KANDA Village	Samutsakhon
	ICON Siam	Bangkok
	Robinson Ratchada	Bangkok
	Robinson Sri Samarn	Bangkok
	The Central - Rama 9	Bangkok
	Robinson, Burirum	Burirum
	Robinson, Samutprakarn	Samutprakarn
	Robinson , Singburi	Singburi
	Siam Global House	Ang Thong
	Macro, Laemchabang	Chonburi
	Big C, Nathavi	Songkla
	Thai Watsadu Rangsit	Bangkok
	Thai Watsadu	Pathumthani
	Grand Home Mart (Bangna)	Samutprakarn
	The PASEO Mall	Bangkok
	Future Park	Pathumthani
Condo-minium / Residential	RHYTHM Asoke	Bangkok
	SKY LINE (Ratanathibeth)	Bangkok
	The BASE 2 -Sukhumvit 77	Bangkok
	The BEST Project - Sukhumvit 77	Bangkok
	The CLOSE	Bangkok
	The COAST - Bangna	Bangkok
	The FITT	Bangkok
	The FUSE - Chan-Sathorn Rd	Bangkok
	The METRO - Rama 9	Bangkok
	The NINE	Bangkok
	The SIGNATURE URBRANO	Bangkok
	TWIN Condo	Bangkok
	U-SATHORN	Bangkok
	DCON	Bangkok
	DEPO	Bangkok
	IDIO - Ta Pra, Sukumvit 115	Bangkok

Application	Project	Province
Condo-minium / Residential	SUPALAI - Rattanathibeth	Bangkok
	Police Apartment Project	Country
	METRO RIVER FRONT : Rattanathibeth	Nonthaburi
Education / Convention Center	Olympus Research Center	Bangkok
	Bitech - Phase 2	Bangkok
	CP Training Center	Nakhon Ratchasima
	S.G. Center	Bangkok
	Faculty Of Education Bansomdejchaopaya Rajabhat University	Bangkok
	Faculty Of Industrial Technology and Agriculture - Bansomdejchaopaya Rajabhat University	Bangkok
	Graham Sullivan, St Andrews International School	Bangkok
	International Dormitory - Chulalongkorn University	Bangkok
	Kasertsart University, Bangkaen Campus	Bangkok
	Srinakharinwirot University	Bangkok
	Suan Disit Rajabhat University	Bangkok
	Western University	Bangkok
	Agriculture industry , Ladkrabung University	Bangkok
	Medical Faculty, Mahidol University	Bangkok
	Suan Dusit Rajabhat University	Bangkok
	Plant Nursery, Maejo University	Chiangmai
	Burapha University	Chonburi
	Mary Immaculate Convent School	Chonburi
	Rajabhat Maharakham University	Maharakham
	Suan Dusit University	Nakhonnayok
	Innovation Building Center, Mahidol University	Nakhonpathom
	Kasertsart University - Kamphaengsaen Campus	Nakhonpathom
	Education Center - Sino Thai	Nonthaburi
	Thammasatkhlongluangwithayakhom School	Pathumthani
	Phetchaburi Rajabhat University	Petchburi
	King Mongkut's University of Technology North Bangkok	Rayong
	Royal Thia Navy Academy	Saraburi
Multi-Purpose Building: Rajabhat Srisakate University	Sisaket	
Operation Building: Thaksin University	Songkla	
Factory	Ichitan Factory - Fire Protection System	Ayutthaya
	Tobacco Factory - Fire Protection System	Ayutthaya
	3 M (Thailand) Ltd.	Bangkok
	Mistine Co., Ltd.	Bangkok
	Thai Union Frozen	Bangkok
	Vanachajgroup Pubic Company Limited	Bangkok
	Tapioca Flour Factory	Buriram
	Fujitrans Co., Ltd.,	Chachoengsao
	Ju Long	Chonburi
	Fly Now Factory Outlet (Sriracha)	Chonburi
	Thai Alloy Manufacturing Co.Ltd	Chonburi
	Thai Yuan Machine Co.,Ltd	Chonburi
	Bridgestone	Nakhonpathom



Reference Projects

Pacific Pipe Products

Application	Project	Province
Factory	Food Star Co.Ltd	Nakhonpathom
	Air-Condition Production Plant	Nonthaburi
	Duangkamon	Pathumthani
	49 Rai Co.,Ltd.	Pathumthani
	Ajinomoto Co.,(Thailand) Ltd.	Pathumthani
	I.P.C. Co. Ltd	Pathumthani
	Thai Tobacco Factory	Ayutthaya
	Sugar Cane Plant	Ratchaburi
	Siam Craft Co., Ltd	Ratchaburi
	Summit Keylex (Thailand) Co., Ltd.,	Rayong
	CPAK Bangpu	Samutprakarn
	Plastic Production	Samutprakarn
	Sinotrans Co. Ltd	Samutprakarn
	SLC-Warehouse	Samutprakarn
	Thai Beverage Can Co. Ltd	Saraburi
	Sugar Cane Plant	Sukhothai
Factory, CHIC	Suphanburi	
Gas Station	PTT Public Co.Ltd.	Chonburi
	PTT Public Co.Ltd.	Kanphaengphet
	Gas Station, LAOS PDR.	LAOS PDR
	PTT Public Co.Ltd.	Rayong
Hospital	Hospital - Chula	Bangkok
	OPD Building, Prapinklao Hospital	Bangkok
	OPD, Nakornsawan Hospital	Nakhonsawan
	OPD,Phuket Hospital	Phuket
	Rama Bangple Hospital	Samutprakarn
	Vipawadee Hospital	Samutsakhon
Hotel	Intercontinental Hotel & Resort, Hua-Hin	Prachuap Khiri Khan
	Ananda Hua-Hin Resort & Spa	Prachuap Khiri Khan
Housing	Bangkok Boulevard , Grand Boulevard, Life Bangkok Boulevard	Bangkok
	Nalin Avenue	Bangkok
	Sampheng 2 (Kanlapapruerk)	Bangkok
	SC ASSET Town Home	Bangkok
	Casa Ville (Sriracha)	Chonburi
	CPN Village	Pathumthani
Eua-Arthorn housing project (Klogn Kud)	Samutprakarn	
Megaproject Infrastructure	MRT - Blue line (1, 4th Contract)	Bangkok
	MRT- Blue line, 2- 4th Contract (Foundation)	Bangkok
	MRT - Purple line, 3rd Contract (Maintenance Center and Park & Ride Building)	Bangkok
	MRT Red Line, 2nd Contract	Bangkok
	MRT-Green line, 1st Contract	Bangkok
	Sri Rat Express Way Project - Outer Ring Road	Bangkok
	Road Construction Project connecting Ratchaphreuk - Kanchanaphisek road	Bangkok
	Rom Klao Bridge	Nonthaburi
	D/B Track Train (Kabinburi - Paktongchai)	Prachin Buri
	D/B Track Train (Kabinburi - Wangnamkaew)	Prachin Buri
Office Building	Maliwan Palace	Bangkok
	Thai Insurance Co.Ltd	Bangkok

Application	Project	Province
Office Building	TV 5	Bangkok
	Government Complex Center	Bangkok
	Innovative Management and Tourism Building - Burapha University	Bangkok
	CAT Telecom	Bangkok
	Dhipaya Insurance Public Co.	Bangkok
	G-Land Co.Ltd	Bangkok
	The PEARL BANGKOK	Bangkok
	ECG Co.,Ltd	Bangkok
	Lotus Land Klong 5	Pathumthani
	Power Plant	Electricity Generating Authority of Thailand
Electricity Power Plant		Lumpang
Electricity Generating Authority of Thailand		Nonthaburi
Metrolotitan Electricity Authority		Nonthaburi
Bangpu Industrial Park		Samutprakarn
Waste Power Plant		Samutprakarn
The Industrial Cogen Power Project		Saraburi
Combined Cycle Power Plant		Saraburi
Showroom		Volvo - Show Room and Service Center (Truck and Bus)
	TOYOTA & UNITED, Bangna Showroom	Bangkok
	TOYOTA - Kunnasari District	Chaiyaphoom
	Solar Rooftop ISUZU	Kanchanaburi
	HONDA : Showroom & Service Center	Maharakham
	TOYOTA	Nakhon Ratchasima
	TOYOTA DISCOVERY	Nakhonpathom
	ISUZU, Showroom	Nakhonpathom
	NISSAN	Phuket
MERCEDES BENZ, Showroom	Ubon Ratchathani	
Sport Center	Sport Administration Center, Sports Authority of Thailand	Bangkok
	Sport Stadium - Nawaminthrachinuthit School	Bangkok
	Mitr Phol Football Stadium	Ratchaburi
Warehouse	Warehouse, Nawanakorn	Ayutthaya
	Grundfos (Thailand) Co.,Ltd	Bangkok
	PK Park	Bangkok
	Thainamthip Co., Ltd	Bangkok
	Nissan Motors Co.Ltd	Chachoengsao
	Pioneer Co.,Ltd	Chachoengsao
	Hayashi Telempu (Thailand) Co.,Ltd	Chonburi
	T-PARK - Panthong	Chonburi
	Truck Terminal - Phuttamonthon	Nakhonpathom
	Thainamthip Co., Ltd	Pathumthani
	PK Park Tip 7	Samutprakarn
	PK Park Tip 8	Samutprakarn
	T-PARK -W1	Samutprakarn
	SEM Factory	Samutprakarn
RBF P Lot 3 Phase 2 - Hemaraj	Saraburi	